



XF

OWNER'S HANDBOOK

Publication Part No. JJM 10 02 40 122

Introduction

ABOUT THIS HANDBOOK

Please take the time to study all of the owner/operator literature supplied with your vehicle as soon as possible.

IMPORTANT

The information contained in this handbook covers all vehicle derivatives and optional equipment, some of which will not be fitted to your vehicle. Due to printing cycles this handbook may include descriptions of options before they become generally available.

If your vehicle is to be used in another geographical area, the vehicle may have to be modified to suit local conditions. Jaguar Cars is not responsible for the cost of any modifications.

The information contained in this publication was correct when it went to print. Subsequent vehicle design changes may result in a supplement being added to the literature pack. Updates can also be viewed on the Jaguar Cars internet site at <http://www.ownerinfo.jaguar.com>.

In the interest of development, the right is reserved to change specifications, design or equipment at any time without notice and without incurring any obligations. This publication, or part thereof, may not be reproduced nor translated without our approval. Errors and omissions excepted.

SYMBOLS USED IN THIS HANDBOOK



Safety warnings indicate either a procedure which must be followed precisely, or information that should be considered with great care, in order to avoid the possibility of personal injury.



Cautions indicate either a procedure which must be followed precisely, or information that should be considered with great care, in order to avoid the possibility of damage to your vehicle.



This recycling symbol identifies those items that must be disposed of safely in order to prevent unnecessary damage to the environment.



This symbol indicates items that must be disposed of correctly, as they contain harmful substances. Seek advice on disposal from your Dealer and/or your local authority.



This symbol identifies those features that can be adjusted, disabled or enabled by your Dealer/Authorised Repairer.

Introduction.....	2	DAB radio	111
Entering the vehicle	4	Portable media	113
Exiting the vehicle.....	9	CD player.....	119
Front seats.....	12	Television	122
Rear seats	17	Video media player	124
Head restraints	20	Voice control	126
Steering wheel.....	22	Telephone.....	128
Occupant safety.....	23	Navigation system	134
Exterior lights	36	Tyre repair kit	147
Interior lights.....	39	Fuel and refuelling	152
Wipers and washers	40	Maintenance	158
Windows	42	Fluid level checks	168
Mirrors	44	Technical specifications	175
Blind spot monitoring.....	46	Vehicle battery.....	182
Garage door opener.....	48	Tyres	185
Warning lamps	51	Fuses.....	188
Message centre	56	Wheel changing.....	194
Touch screen.....	58	Vehicle recovery	197
Heating and ventilation	63	After a collision	198
Luggage compartment	67	Vehicle identification	200
Towing	69	Type approval.....	202
Storage compartments.....	72	Controls overview.....	224
Starting the engine	74		
Intelligent stop/start	79		
Gearbox.....	81		
Stability control	83		
Brakes	87		
Tyre pressure monitoring system... ..	89		
Parking aids.....	92		
Cruise control.....	94		
Adaptive cruise control.....	96		
Automatic speed limiter.....	103		
Audio/video overview	104		
Radio.....	109		

Entering the vehicle

UNLOCKING THE VEHICLE

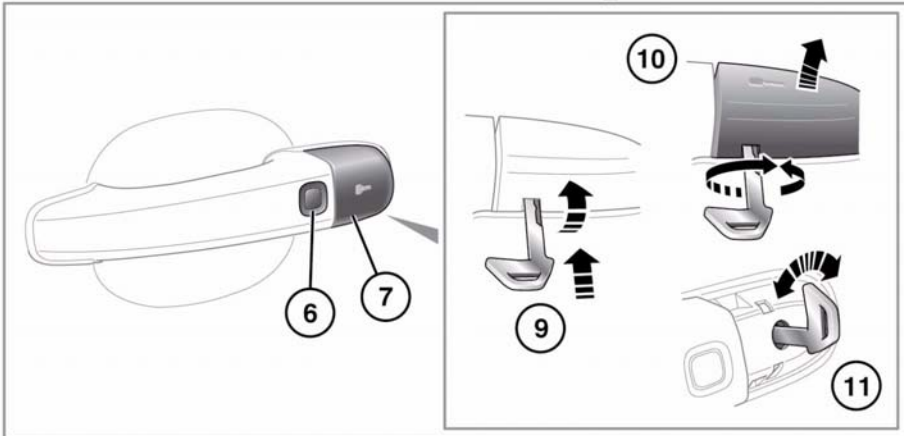
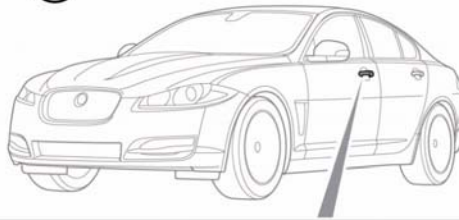
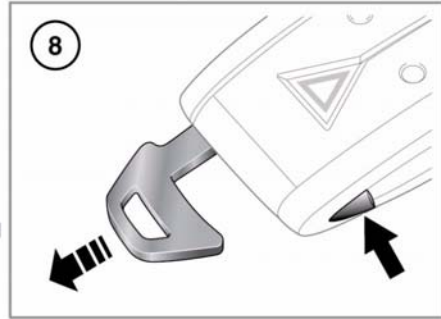
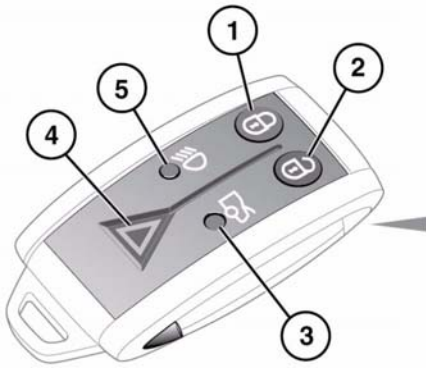

E134457

1. Press the lock button to secure the vehicle. The vehicle can be Single or Double locked. See **9, SINGLE LOCKING** and **9, DOUBLE LOCKING**.
 2. Your vehicle can be unlocked using either Single or Multi-point entry.

When single point entry is enabled the first press unlocks the driver's door and enables the other doors to be opened from the inside. The hazard warning lamps will flash twice, to indicate that the vehicle is unlocked and the alarm has been disarmed.

A second press unlocks the passenger doors and the luggage compartment.

If multi-point entry is enabled, press briefly to unlock all the doors and luggage compartment and to disarm the alarm. The hazard warning lamps will flash twice to indicate that the vehicle is unlocked and the alarm has been disarmed.

To change from Single to Multi-point entry (or vice versa), press both the lock and unlock buttons simultaneously for three seconds. The hazard warning lamps will flash twice to confirm the change.

The change can also be achieved using the touch screen. See **61, VEHICLE SETTINGS**.
 3. Press to open the luggage compartment. The vehicle security system will remain active for the period the luggage compartment is open, but the intrusion and inclination sensing systems will be inhibited. Door and bonnet security will remain active.

The security system will re-arm to its previous state when the luggage compartment is closed.
 4. Panic alarm: Press and hold for three seconds, or press three times within three seconds, to activate the horn, siren and hazard lamps.

After five seconds, the alarm can be cancelled by pressing the button and holding for three seconds, or pressing three times within three seconds.

The emergency alarm will also be cancelled if the vehicle detects a valid Jaguar Smart Key when the START/STOP button is pressed.
 5. Press to switch on the approach illumination for up to 120 seconds. The illumination time is set using the exit delay switch. Pressing the button again or operating the starter button, will turn the approach lamps off.
 6. Keyless locking button. See **10, KEYLESS LOCKING**.
 7. Door lock cover.
 8. Press and hold the emergency key release button, while pulling the emergency key from the Jaguar Smart Key body.
 9. Insert the emergency key blade into the slot at the base of the door lock cover and gently lever the key blade upwards.
 10. Carefully twist the key blade, to lever the cover off the retaining clips.
 11. Insert the key blade into the exposed lock to operate.
- To lock:** Ensure all the doors are closed, then turn the key blade towards the front of the vehicle and release. This will lock all doors but will not arm the alarm.

Entering the vehicle

To unlock: Turn the key blade towards the rear of the vehicle and release. If the security system is disarmed, all doors and the luggage compartment will be unlocked. If the security system is armed, only the front left-hand door will unlock.

If the vehicle is unlocked using the emergency key blade with the security system armed, the alarm will sound when a door is unlocked. To deactivate the alarm, press the unlock button on the Jaguar Smart Key or press the engine START/STOP button with the Smart Key inside the vehicle.

Replacing the door lock cover:

1. Align the cover to engage the bottom two clips.
2. Push the top of the cover to engage the upper clip.

KEYLESS ENTRY



Any person fitted with an implanted medical device should ensure that the device is kept at a distance of at least 22 cm (8.7 inches) away from any transmitter mounted in the vehicle. This is to avoid any possibility of interference between the system and device. For information concerning the locations of the security system transmitters, see 181, REMOTE KEY FOB TRANSMITTER LOCATIONS.



If a remote control is lost, a replacement can be obtained and programmed to the vehicle by a Jaguar Dealer/Authorised Repairer. Notify a Jaguar Dealer/Authorised Repairer as soon as a remote control is lost or stolen and have the remaining remote control(s) reprogrammed.



The Smart Key may not be detected if it is placed within a metal container or if it is shielded by a device with a back-lit LCD screen, such as a smart phone, laptop (including laptop bag), games console etc. Keep the Smart Key clear of such devices when attempting Keyless entry or Keyless starting.

Keyless entry allows the vehicle to be unlocked and disarmed by simply operating the door handle, provided the Jaguar Smart Key is within 1.0 m (3 feet).

The Smart Key needs only to be on the driver's person, it does not need to be exposed or handled. However, the Smart Key may not be detected if it is placed within a metallic container.

Note: *Keyless entry will unlock the vehicle in accordance with the current security setting (Single-point or Multi-point entry). However, if Single-point entry is the current setting and a door other than the driver's door is opened first, all doors will unlock.*

When all open doors have been closed, the system will search the vehicle interior for a valid Smart Key. If one is not detected, **SMART KEY NOT FOUND, PLEASE INSERT IN SLOT** will be displayed in the message centre. Find the Smart Key and insert it into the starter control unit (see **76, IF THE ENGINE FAILS TO START**).

The security system fitted to your vehicle is Thatcham category 1 approved, and meets EU regulations 97/116 and EU directive 95/56 EC.

CONVENIENCE MODE

When the door is opened using either the Jaguar Smart Key or keyless entry, the vehicle's electrical system initiates the convenience mode. The following systems become functional:

- Driver position memory.
- Seat and steering column adjustment.
- Interior and exterior lighting.
- Message centre.
- Auxiliary power socket.

GLOBAL OPENING

Press and hold the unlock button on the Jaguar Smart Key for 3 seconds or press and hold the exterior lock button. The vehicle will unlock and the alarm will be disarmed immediately. After the 3 seconds all of the windows and sunroof will open.

To stop window movement during global opening when using the Smart Key, press any of the buttons on the Smart Key or operate the driver's window switch. To stop a particular window from opening, operate the relevant window switch.

To stop window movement when global opening using the exterior lock button, release the button.

Note: *Global opening can be enabled/disabled via the Security/ vehicle settings menu on the touch screen. See 61, VEHICLE SETTINGS.*

DRIVE-AWAY LOCKING

Locks all the doors when the vehicle exceeds a set speed. One of three set speeds can be selected via the Security/ vehicle settings menu on the touch screen. See 61, **VEHICLE SETTINGS**. Use of the central locking/ unlocking buttons (see 224, **DRIVER CONTROLS**), will override the drive-away locking feature for the rest of a journey.

If a door is individually unlocked and opened, all doors will relock when the open door is subsequently closed.

Note: *Drive-away locking can be enabled/ disabled via the Security/ vehicle settings menu on the touch screen. See 61, VEHICLE SETTINGS.*

REMOTE KEY FOB CARE



To prevent accidental operation, never leave the Jaguar Smart Key in the vehicle if children or animals are also left in the vehicle.



Do not expose to extremes of heat, dust, humidity or fluids. Do not leave the transmitter exposed to direct sunlight.

The emergency key blade number is recorded on an attached label, which should be peeled off and affixed to the correct area on the Security Card, supplied in the literature pack. Keep the Security Card safe, but not in the vehicle.

The operational range of the Smart Key varies considerably, depending on atmospheric conditions and interference from other devices.

Note: *The radio frequency used by the Smart Key may be used by other devices (e.g. medical equipment). This may prevent the Smart Key from operating correctly.*

Entering the vehicle

REMOTE KEY FOB BATTERY REPLACEMENT

When the battery needs renewing, there will be a significant decrease in the effective range and the message **SMART KEY BATTERY LOW** is displayed in the message centre.

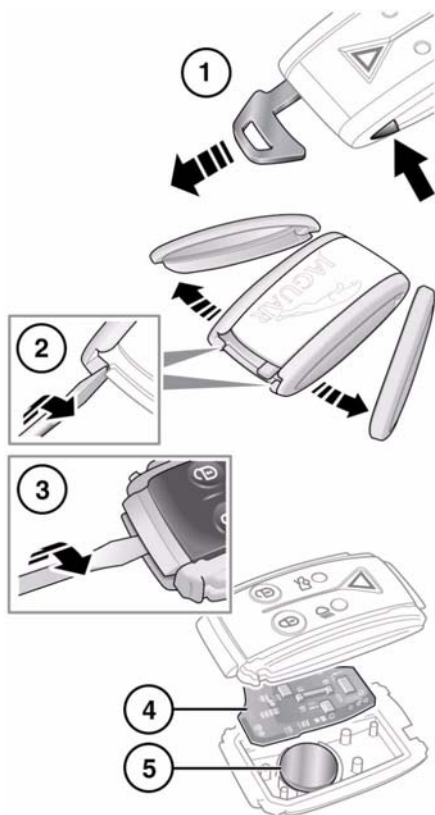

E134307

To renew the battery:

1. Press the release button on the side of the Jaguar Smart Key and pull the key blade from the Smart Key.
2. Remove the two side covers, one at a time, by inserting a small flat-bladed screwdriver between the cover and body, then gently twist the screwdriver.
3. Insert the screwdriver between the two body halves and twist gently to separate.
4. Remove the printed circuit board, taking care not to touch the battery terminals.
5. Remove the old battery, then fit a new CR2032 type battery (available from your Dealer/Authorised Repairer), with the positive (+) side downwards.

Refit the parts in reverse order, ensuring they click securely into place.



Battery disposal: Used batteries must be disposed of correctly, as they contain harmful substances. Seek advice on disposal from your Dealer and/or your local authority.

DOOR LOCK AND RELEASE LEVERS

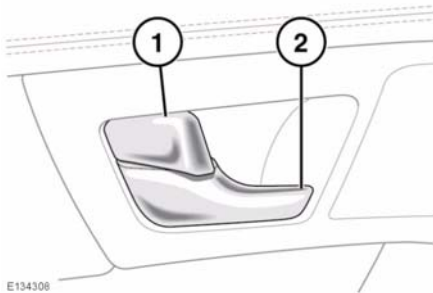

1. Press the locking lever to lock the door, pull the lever to unlock the door. Operating the locking lever on either front door will lock or unlock all closed doors.
2. Pull the release lever to open a door. If a rear door is locked, operating the lever will have no effect.

Note: If the car was locked using the Jaguar Smart Key, then operating the locking/release lever will only unlock/release that door and the alarm will sound.

Note: If the vehicle has been double-locked, then the interior door lock and release levers will not operate. The vehicle must be unlocked using the Jaguar Smart Key.

SINGLE LOCKING

Press the lock button briefly. Single locking secures the vehicle and prevents the doors and luggage compartment being opened from outside of the vehicle. The doors can be unlocked and opened from inside the vehicle. The hazard warning lamps will flash once as confirmation.

DOUBLE LOCKING



Never double lock the vehicle with people, children or pets inside. In the event of an emergency they would be unable to escape, and the emergency services would be unable to release them quickly.

When the vehicle is double-locked the doors cannot be opened, either from inside or outside the vehicle.

Press the lock button twice within three seconds. Double locking secures the vehicle and prevents the doors and luggage compartment being unlocked or opened from inside or outside of the vehicle, except with the correct Jaguar Smart Key. The hazard warning lamps will flash twice (with a long second flash) and an audible warning will sound, as confirmation.



The audible warning can be enabled/ disabled by your Dealer/Authorised Repairer.

LOCK CONFIRMATION

If you are uncertain whether the vehicle is locked and armed (either by single or double locking), press the lock button again. The hazard warning lights will flash to indicate and confirm the current armed/disarmed status.

Note: If the vehicle is **not** already locked and armed, pressing the lock button will single lock the vehicle. Press again to double lock.

Exiting the vehicle

MISLOCK

If one of the doors, the bonnet, or the luggage compartment are not shut fully when the vehicle is locked using the Jaguar Smart Key or by Keyless locking, the vehicle will not lock and two warning tones will sound. Check that all doors, the bonnet and the luggage compartment are closed properly and lock the vehicle again.

If one or more of the doors fails to lock properly when a lock attempt is made using the Jaguar Smart Key, two warning tones will sound and one or more of the doors may not be locked.

GLOBAL CLOSING



Ensure that no children, pets, or obstructions are in any open aperture before operating global closing.

Ensure that all doors are closed, then press and hold the lock button on the Smart Key for 3 seconds or press and hold the lock button on the exterior door handle. The vehicle will single lock and the alarm will be fully armed immediately. After 3 seconds all of the windows will close.

Note: *If the button on the door handle is released before the windows have fully closed, the windows will stop closing.*

Note: *Global closing can be enabled/disabled via the Security/ vehicle settings menu on the touch screen. See 61, VEHICLE SETTINGS.*

KEYLESS LOCKING



Remove all Jaguar Smart Keys and emergency key blades from the vehicle when it is left unattended. This will help prevent the alarm being disarmed and therefore help prevent theft.



The Smart Key may not be detected if it is placed within a metal container or if it is shielded by a device with a back-lit LCD screen, such as a smart phone, laptop (including laptop bag), games console etc.

The vehicle will not lock automatically.

To single-lock the vehicle, press the button on the door handle once. The hazard warning lamps will flash once as confirmation (in some markets, an audible warning will sound).

To double-lock the vehicle, press the button twice within three seconds. The hazard warning lamps will flash twice (with a long second flash). In some markets, a double audible warning will sound.

Note: *Keyless locking will only activate if all doors, bonnet and the luggage compartment are closed and the Jaguar Smart Key is outside the vehicle. If the above conditions are not met, two audible error warnings will sound.*

FULL ALARM

To set full alarm protection, ensure that all the windows and the sunroof are closed. Then, on vehicles fitted with double-locking, press the lock button twice within three seconds. The hazard warning lights will flash twice to confirm the alarm state and, in some markets, an audible tone will sound.

Note: *If the alarm is armed and a window or the sunroof are left open, the alarm may sound due to movement of air currents, detected by the intrusion sensors in the front interior light console.*

Note: *The intrusion sensors can be temporarily disabled, for the next time the vehicle is locked, via the Security/ vehicle settings menu on the touch screen. See 61, VEHICLE SETTINGS.*

PERIMETER ALARM

To set perimeter alarm protection, briefly press the lock button once. The hazard warning lights will flash once to confirm the alarm state.

BATTERY-BACKED SOUNDER

In certain markets, a separate battery backed sounder is fitted. This device will sound the alarm if the vehicle battery or the alarm sounder is disconnected when the security system is armed.

DEACTIVATING THE ALARM WHEN TRIGGERED

If the alarm has been triggered, it can be deactivated by any one of the following methods:-

- Pressing the unlock button on the Jaguar Smart Key.
- Opening a door using keyless entry.
- Pressing the START/STOP button with a valid Jaguar Smart Key present.

TILT SENSOR

The tilt sensor detects any change in the vehicle's angle to the ground. When the alarm is armed and the vehicle double-locked, any change in the vehicle's angle will activate the tilt alarm.

Note: *The tilt sensor can be temporarily disabled, for the next time the vehicle is locked, via the Security/ vehicle settings menu on the touch screen. See 61, VEHICLE SETTINGS.*

PASSIVE ARMING

This vehicle is fitted with a passive arming feature which can, if enabled, automatically arm the anti-theft system. Passive arming will automatically arm the perimeter alarm system 60 seconds after the driver's door is closed, provided all doors, bonnet and luggage compartment are closed, the ignition is switched off and there are no valid Jaguar Smart Keys inside the vehicle.

Passive arming will not lock the vehicle, although access to the luggage compartment via the interior or exterior release buttons will be prevented and the fuel filler flap will be locked.

AUTOMATIC RELOCKING AND RE-ARMING OF THE ALARM

Automatic relock and re-arm is a feature which, if enabled, automatically relocks the vehicle and arms the anti-theft system.

If the vehicle is in a locked and armed state and the remote unlock button is pressed, but none of the doors or the luggage compartment are opened within 1 minute, the vehicle will automatically relock all the doors and the luggage compartment and will re-arm the alarm system.

Note: *Automatic relocking and arming will only relock and arm to the last locked and armed state.*

SENSOR FAULTS

If the security systems detect a fault with one of the security sensors, 2 error tones will sound from the alarm after the vehicle is unlocked and disarmed. If this condition occurs, please visit your Dealer/Authorised Repairer for rectification.

Front seats

ELECTRIC SEATS

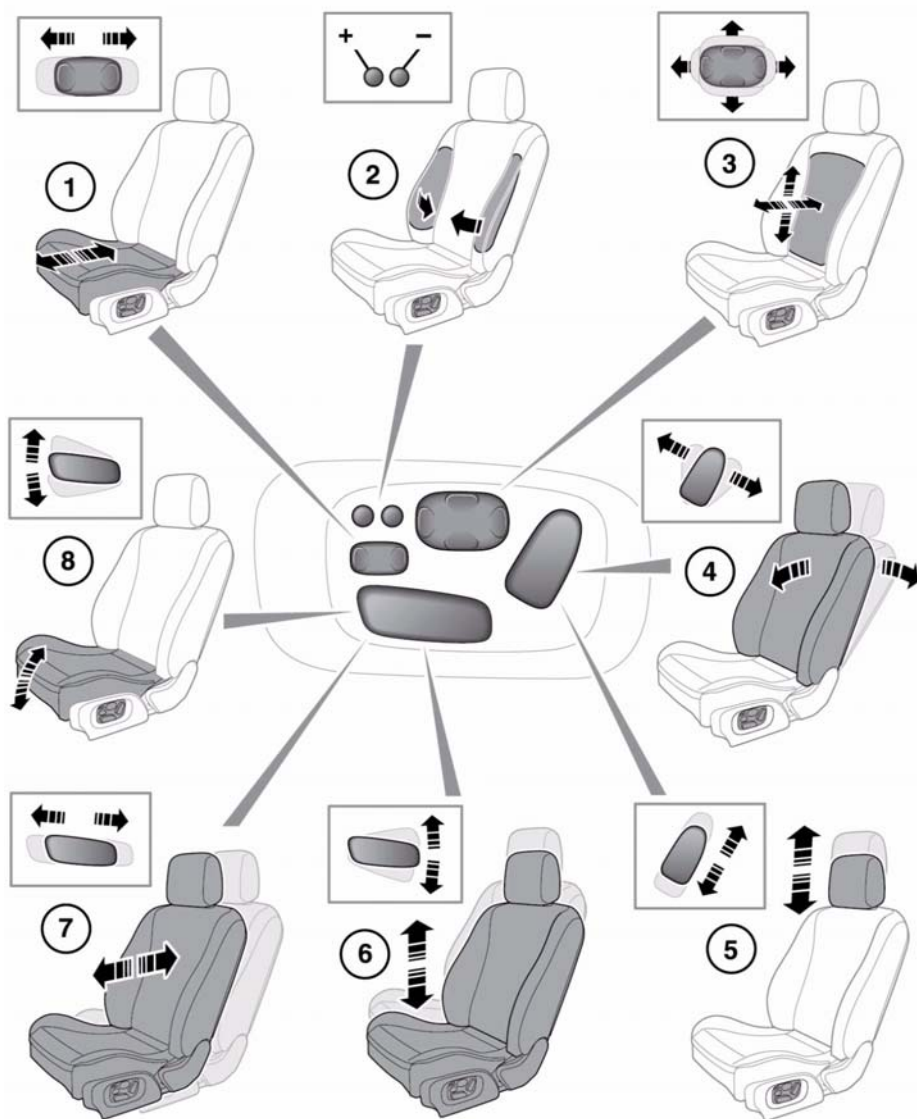

E132387

1. Cushion length adjustment.
2. Bolster adjustment:
 - Bolster inflate.
 - Bolster deflate.
3. Lumbar support adjustment.
4. Seat back angle adjustment.
5. Head restraint height adjustment.
6. Height adjustment.
7. Fore and aft adjustment.
8. Cushion front tilt adjustment.

To adjust the seats, the Jaguar Smart Key must be in the vehicle and the ignition turned on.

If an obstruction is encountered while the seat is in motion, the seat will stop moving and further movement will be restricted until reset.

To reset the seat:

1. Remove the obstruction.
2. Adjust the seat to the point where movement is restricted.
3. Press and hold the switch for at least 2 seconds to override the restriction.

Front seats

MANUAL SEATS

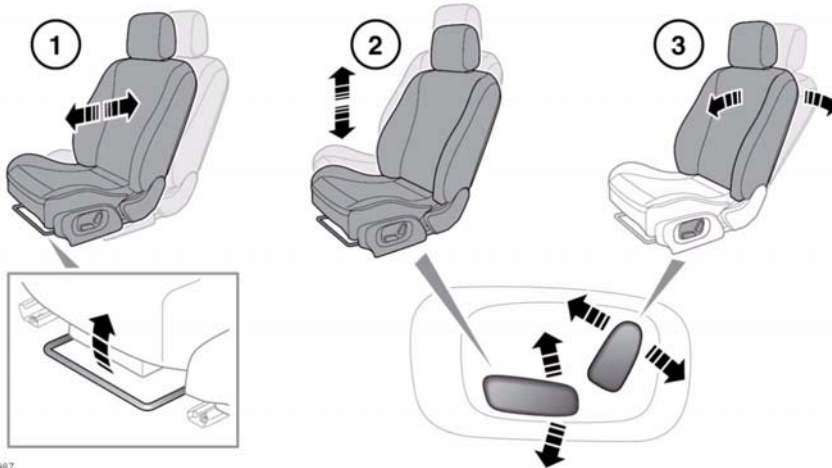

E 134987



Do not adjust the seat while the vehicle is moving. Doing so could cause loss of vehicle control and personal injury.

1. Fore and aft adjustment.
2. Height adjustment.
3. Seat back angle adjustment.

DRIVING POSITION MEMORY

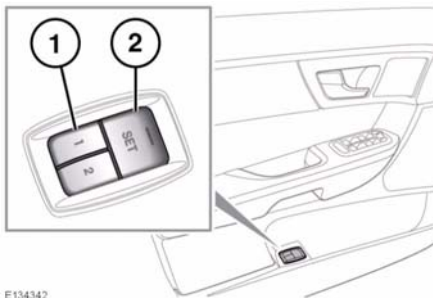

E134342

1. Memory presets.
2. Memory set button.

Once you have adjusted the driver's seat, steering column (see **22, ADJUSTING THE STEERING WHEEL**) and exterior mirrors (see **44, EXTERIOR MIRRORS**), the vehicle can memorise these settings using the driver memory buttons.

Once the passenger seat has been adjusted as desired, these settings can be memorised using the passenger memory buttons.

1. Press the memory set button to activate the memory function.
2. Press one of the preset buttons within 5 seconds to memorise the current settings. For the driver's settings, **MEMORY 1 (or 2) SETTINGS SAVED** will be displayed on the message centre accompanied by an audible chime to confirm the settings have been memorised.

A seat position can only be memorised during the five second period.

Any existing settings for a memory preset will be over-written when programming a memory position.



RECALLING A MEMORISED POSITION

Press the appropriate memory preset button (for the driver's settings, **MEMORY 1 (or 2) SETTINGS RECALLED** will be displayed in the message centre).

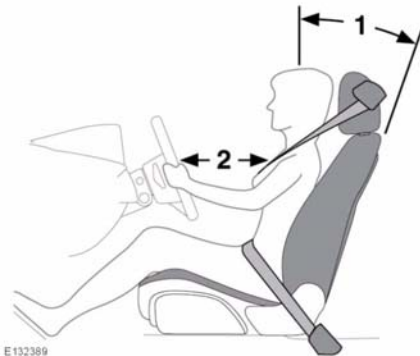
SITTING IN THE CORRECT POSITION



E132389

-  **The driver and front passenger must not ride with the seat fully reclined.**
-  **Do not adjust the seat while the vehicle is moving.**

The seat, head restraint, seat belt and airbags, all contribute to the protection of the user. Correct use of these components will give you greater protection, therefore you should observe the following points:

1. Sit in an upright position with the base of your spine as far back as possible and the seat back reclined no more than 30 degrees.

Front seats

2. Do not move the driver's seat too close to the steering wheel. Ideally, a minimum distance of 254 mm (10 inches) is recommended between the breastbone and the steering wheel airbag cover. Hold the steering wheel in the correct position with your arms slightly bent.
- Adjust the head restraint so that the top of the head restraint is above the centre line of the head.
 - Position the seat belt so that it is mid-way between your neck and your shoulder. Fit the strap tightly across your hips, not across your stomach.
 - Ensure that your driving position is comfortable and enables you to maintain full control of the vehicle.

PASSENGER SEAT AWAY







E135027

This feature allows the fore and aft position of the front passenger seat to be adjusted from the driver seat and rear passenger seats. Press the front of the button to move the seat forwards; press the rear of the button to move the seat rearwards.

REAR SEAT SAFETY

-  All vehicle occupants should be seated correctly, and wear a seat belt at all times when the vehicle is in motion.

FOLDING THE REAR SEATS

-  All items carried in the vehicle should be properly secured. See 68, **LUGGAGE ANCHOR POINTS**. Unsecured items can cause death or serious injury in the event of an impact or sudden manoeuvre.
-  When using seat belts to restrain items other than occupants, ensure that the belts are not damaged or exposed to sharp edges.
-  Never allow passengers to travel in the luggage compartment under any circumstances.
-  Always take note of safety warnings and labels attached to the rear seats. The labels give advice on safely folding and erecting the seats.
-  Ensure that the removed head restraints are stored securely. Never leave them loose in the vehicle, as they can cause serious injury or death in the event of an accident, heavy braking or sudden manoeuvre.

Rear seats

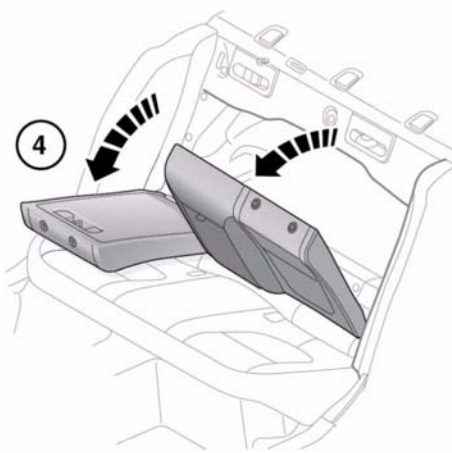
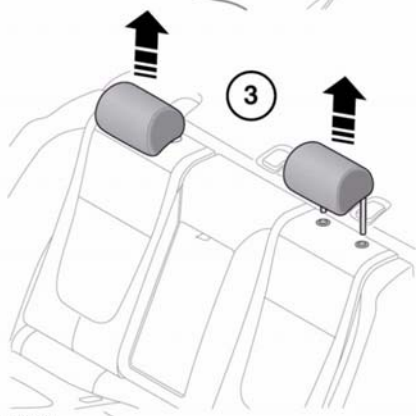
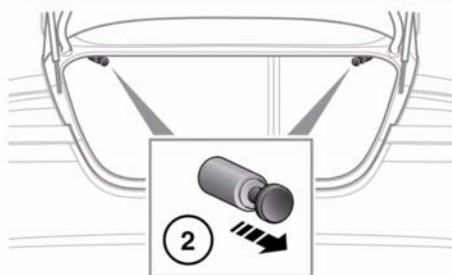

E134297

1. Stow the rear arm rest.
2. With the luggage compartment open, pull the relevant seat release button, located as shown (view from the rear of the vehicle with the luggage compartment open shown).
3. Remove the head restraint(s) from the area(s) of the seat back to be folded.
4. Full fold the seat back forwards and, if required, repeat the process for the second seat section.

ERECTING THE REAR SEATS



Ensure that when the seat back is raised, the seat belts are routed correctly and are not trapped by the seat back.



Ensure that when the seat back is raised, the locking mechanism is fully engaged.



Before driving, ensure that the head restraints are correctly fitted to the rear seats. See 21, REAR HEAD RESTRAINT REMOVAL.

SKI HATCH

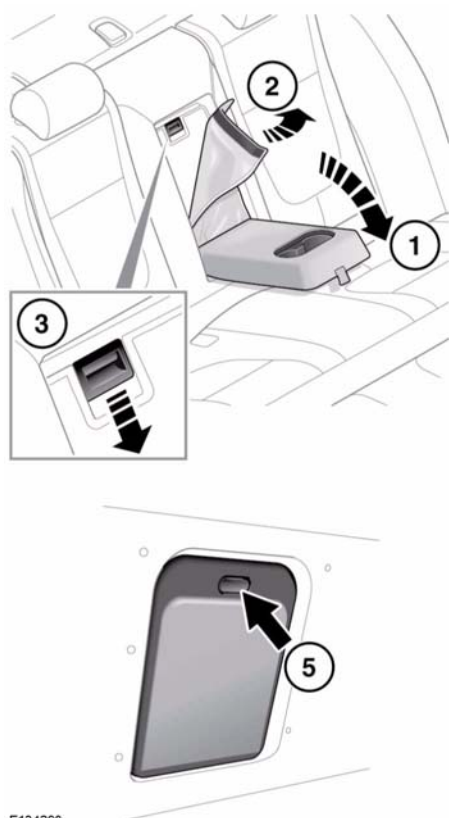

E134298

1. Fold down armrest.
2. Pull leather flap forward.
3. Press catch down to release the inner hatch door and lower onto armrest.
4. Pull ski bag from the hatch into the vehicle and loosen retaining strap.
5. From the luggage compartment, press the catch down to release the outer hatch door.

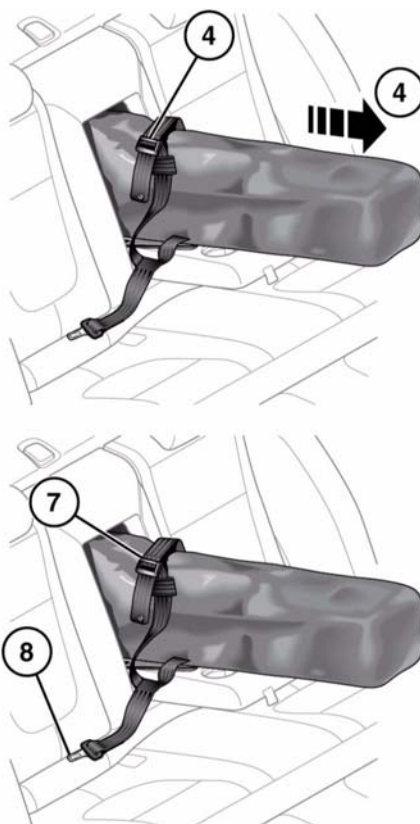



6. Push the skis through the hatch into the ski bag.
7. Secure the skis by tightening the ski bag retaining strap.
8. Clip the strap connector into the centre rear seat belt buckle.

Head restraints

FRONT HEAD RESTRAINTS

 Adjust the head restraint so that the top of the head restraint is above the centre line of the head. An incorrectly adjusted head restraint increases the risk of death or serious injury in the event of a collision.

 It is possible to swivel the head restraint forwards or backwards. For greater protection in the event of a collision, the head restraint should be adjusted so that it is as close to the back of the head as is practical.

 Never adjust the head restraints while the vehicle is in motion.

Powered head restraints:

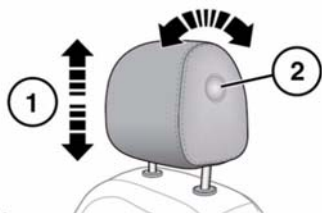

E135416

1. To adjust the height of the head restraint, see **12, ELECTRIC SEATS**.
2. To adjust the angle of the head restraint, press the locking button on the side of the restraint and tilt to the desired position.

Note: It is not possible to remove powered head restraints.

Manual head restraints:

 Do not drive or carry passengers with the head restraint removed from an occupied seat. The absence of a correctly adjusted head restraint increases the risk of neck injury in the event of a collision.

 Always store a removed head restraint securely.

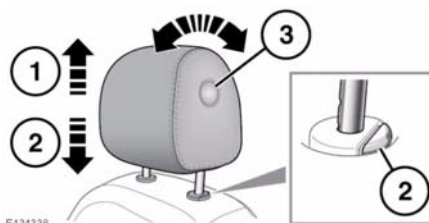

E134338

1. To raise, pull the restraint upwards, it will click and lock in position.
Note: Do not try to raise the head restraint further than the third adjustment position.
2. To lower, depress the locking collar and push down on the restraint.
3. To adjust the angle of the head restraint, press the locking button on the side of the restraint and tilt to the desired position.

Note: The head restraint can only be removed if the seat is moved forward or back to create more space.

Manual head restraints may be removed, if required (e.g. to fit larger child seats). Raise the head restraint to its uppermost position and press the locking collar. Lift the restraint out of the seat back.

Ensure the head restraint is refitted before the seat is used by a passenger.

To refit the head restraint, ensure it is facing the correct direction, insert the stems of the head restraint into the sockets and push it downwards until at least the first click.

REAR HEAD RESTRAINTS

 Head restraints are designed to support the head, not the back of the neck. The head restraint must be positioned correctly to restrain rearward movement of the head in the event of a collision.

 While stationary, adjust the head restraint so that the top of the head restraint is above the centre line of the head. An incorrectly adjusted head restraint increases the risk of death or serious injury in the event of a collision.

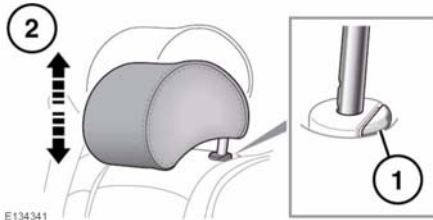

1. If the head restraint is to be lowered, press and hold the locking collar (it is unnecessary to press the locking collar to raise the restraint).
2. Move the head restraint up or down to the required position.

REAR HEAD RESTRAINT REMOVAL

 Do not drive or carry passengers with the head restraint removed from an occupied seat. The absence of a correctly adjusted head restraint increases the risk of neck injury in the event of a collision.

 Always store a removed head restraint securely.

It is possible to remove the rear head restraints, if required (e.g. to enable the fitment of a child restraint), as follows:

- Raise the head restraint to its uppermost position and press the locking collar.
- Lift the head restraint out of the seat.

Ensure the head restraint is refitted before the seat is used by a passenger.

To refit the head restraint, ensure it is facing the correct direction, insert the stems of the head restraint into the sockets and push it downwards until at least the first click.

Steering wheel

ADJUSTING THE STEERING WHEEL

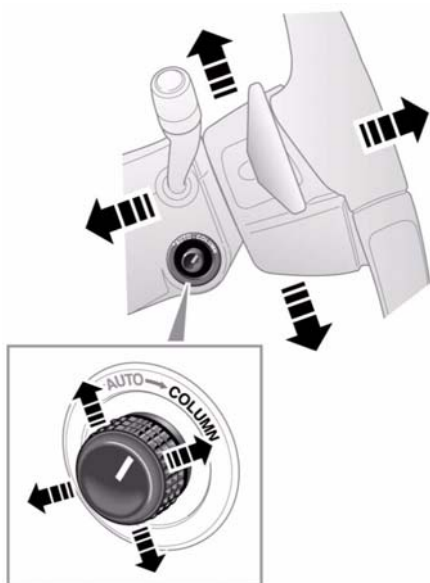

E134339

⚠ Never adjust the steering wheel whilst the vehicle is moving.

ⓘ Do not use steering wheel mounted security devices. Movement of the steering wheel in exit and entry mode, could result in damage to the vehicle or possible injury to the occupant.

The steering wheel can be adjusted for tilt and reach as follows:

- Move the control forwards or rearwards to adjust reach.
- Move the switch up or down to adjust tilt.

Two steering wheel positions can be stored and recalled, along with seat and exterior mirror positions, by the driving position memory. See **15, DRIVING POSITION MEMORY**.

ENTRY AND EXIT MODE

With the steering column adjustment control in the AUTO position, the steering column will move to provide easier entry and exit from the vehicle, as follows:

- **Exit:** When the driver's door is opened, the steering column will move to the uppermost tilt position.
- **Entry:** When the driver's door is closed and the ignition is turned on, the steering column will return to its previously selected driving position.

Note: If the column control is moved away from AUTO when the column is in the Exit position, the column will still move back to its previous driving position when the driver's door is closed and the ignition is switched on.







Note: If the column is manually adjusted during Entry or Exit operation, column movement will stop.

HEATED STEERING WHEEL



Touch this icon on the touch screen Home or Climate menu, to activate the steering wheel heater. Press again to turn off.

SEAT BELT SAFETY

-  Care should be taken to avoid contamination of the webbing with polishes, oils and chemicals, and particularly battery acid. Cleaning may safely be carried out using mild soap and water.
-  The belt should be replaced if webbing becomes frayed, contaminated or damaged.
-  It is essential to replace the entire assembly after it has been worn in a severe impact, even if damage to the assembly is not obvious.
-  Do not carry hard, fragile or sharp items between your person and the seat belt.
-  Seat belts should be worn by all vehicle occupants, for every journey, no matter how short.
-  When using seat belts to restrain items other than occupants, take care to ensure that the belts are not damaged, or exposed to sharp edges.
-  The use of comfort clips, or devices that would create slackness in the seat belt system, is not advised.

SEAT BELT CHECKS

Note: If the vehicle is parked on an incline, the seat belt mechanism may lock. This is a safety feature and the belt should be gently eased out from the upper anchorage.

The seat belts should be inspected regularly to check for fraying, cuts or wear to the webbing, and the condition and security of the

mechanism, buckles, adjusters, and mounting points.

- With the seat belt fastened, give the webbing near the buckle a quick upward pull. The buckle must remain securely locked.
- With the seat belt unfastened, unreel the seat belt to the limit of its travel. Check that it unreels smoothly with no snatches or snags. Allow the belt to fully retract, again checking for smooth operation.
- Partially unreel the seat belt, then hold the tongue plate and give a quick forward pull. The mechanism must lock and prevent any further unreeling.

If any of the seat belts fail to meet those criteria, immediately contact your Dealer/ Authorised Repairer.

Occupant safety

USING SEAT BELTS AND CHILD SAFETY LOCKS

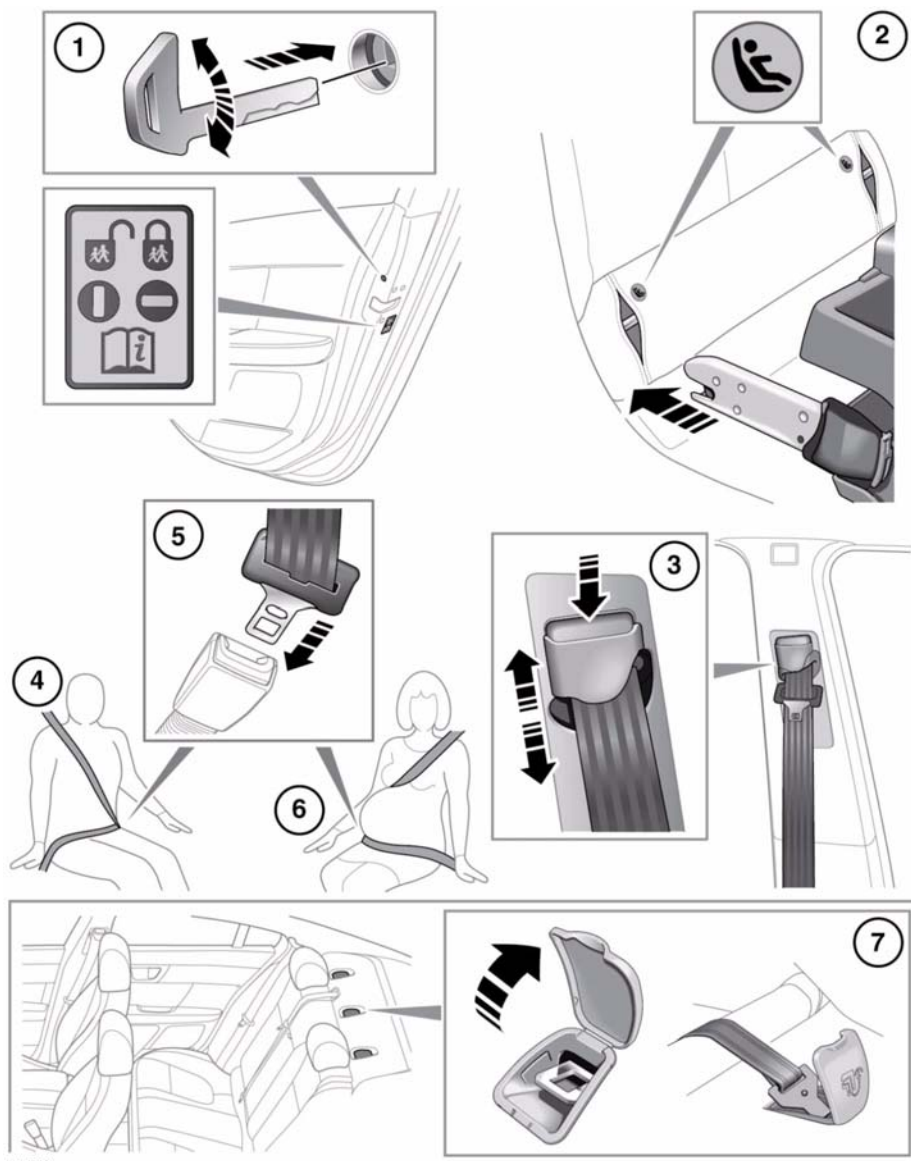

1. If children are to be carried in the rear seat positions, it is recommended that the rear door interior handles are disabled.

To change the child lock settings:-

- Open the door to access the child safety lock.
- Insert the emergency key into the slot and rotate a quarter of a turn, to enable or disable the interior door handle, as required.

2. To install an ISOFIX child seat (not Australia):-

- Raise the head restraint on the relevant seat.
- Locate the lower anchor bars which are accessible through the gap between the seat back and seat base. Insert the protective guides supplied with the child seat as shown. The insertion positions for the guides are identified by the ISOFIX labels.
- Slide the child seat locking mechanism into the protective sleeves and onto the anchor bars.
- Test the security of the child restraint. To do this, attempt to pull the restraint away from the vehicle seat and twist the restraint from side to side. Even if the restraint appears secure you should always check the anchor points visually to ensure correct attachment.

Note: Always ensure that if an upper tether is provided, it is fitted and tightened correctly.

3. To adjust the seat belt height:-

- Press to release the catch.
- With the catch depressed slide the mechanism up or down to the required height. Release the catch and ensure the locking mechanism has engaged.



The use of comfort clips or devices that would create slack in the seat belt system, is not advised.



No modifications or additions should be made by the user which will either prevent the seat belt adjusting devices from operating to remove slack, or prevent the seat belt assembly from being adjusted to remove slack.

4. Draw the belt out smoothly, ensure that the belt height, the seat, and your position on the seat are correct.



Seat belts are designed to bear upon the bony structure of the body, and should be worn low across the front of the pelvis or the pelvis, chest and shoulders, as applicable; wearing the lap section of the belt across the abdominal area must be avoided.



Seat belts should be adjusted as firmly as possible, consistent with comfort, to provide the protection for which they have been designed. A slack belt will greatly reduce the protection afforded to the wearer.



Belts should not be worn with the straps twisted.



Each belt assembly must only be used by one occupant; it is dangerous to put a belt around a child being carried on the occupant's lap.



The occupants of the front seats should not travel with the seat back at more than 30 degrees from upright. Doing so will reduce the protection afforded by the seat belt.

Occupant safety



Never place anything between you and the seat belt. It can be dangerous and reduce the effectiveness of the seat belt in preventing injury.

5. With the seat belt correctly positioned, place the metal tongue into the buckle nearest to you. Press it in until a click is heard. Ensure that all slack has been taken up by the retractor and the belt fits tightly across the hips.

To release the seat belt, press the red button.

Note: When releasing the seat belt it is advisable to hold the belt before pressing the release button. This will prevent the belt from retracting too quickly.

6. **Use of seat belts during pregnancy:**

Position the lap strap comfortably across the hips beneath the abdomen. Place the diagonal part of the seat belt between the breasts and to the side of the abdomen.



Position the seat belt correctly for the safety of the mother and unborn child. Never wear just the lap strap, and never sit on the lap strap whilst using just the shoulder strap. Both of these actions are extremely dangerous and increase your risk of serious injury in the event of an accident or during emergency braking.



Never place anything between you and the seat belt in an attempt to cushion the impact in the event of an accident. It can be dangerous and reduce the effectiveness of the seat belt in preventing injury.



Ensure that the seat belt is not slack or twisted.

7. Tether strap anchorages. See **31, INSTALLING TETHER ANCHORAGE CHILD RESTRAINTS**.



Child restraint anchorages are designed to withstand only those loads imposed by correctly fitted child restraints. Under no circumstances are they to be used for adult seat belts, harnesses or for attaching other items or equipment to the vehicle.



If a child seat or restraint system is to be fitted to the centre seating position, the centre armrest must be in the stowed position (folded into the seat).

Note: A tether anchorage is provided for the centre seat position. Do not use this anchor position with an ISOFIX child seat.

SEAT BELT WARNING LAMP



The warning lamp in the instrument panel stays illuminated when the driver's or front passenger's seat belt is not fastened (if the passenger seat is occupied). The lamp should extinguish when the seat belt is fastened.

The warning lamp will also flash in conjunction with the Beltminder warning chime.

BELTMINDER



The belt minder system warns the driver (using the seat belt warning lamp) when the seat belt of an occupied front seat is not fastened or is unfastened during a journey.

If the vehicle is moving at or above 16 km/h (10 mph) and the seat belt of an occupied front seat is not fastened, the warning lamp will flash.

The flashing lasts for 10 seconds and repeats every 10 seconds for approximately 5 minutes or until the belt(s) is fastened or the vehicle stops.

If the warning lamp remains illuminated after the seat belt(s) fastened, seek qualified assistance as soon as possible. The vehicle can still be driven with the warning lamp illuminated, provided the seat belt(s) is properly fastened.

Note: *If a heavy object is placed on the front passenger seat, it may activate the Beltminder feature. It is recommended that the object be placed in the luggage compartment or secured using the seat belt.*

Note: *Although not advisable, it is possible to disable the Beltminder function. Please see your Dealer/Authorised Repairer to disable or re-instate the function.*

ACTIVE SEAT BELTS

The Active Seat Belt System enhances front seat occupant support during extreme vehicle manoeuvres such as understeer, oversteer or high braking forces by tensioning the seat belt.

Tension is released when the vehicle manoeuvre is completed. The occupant may notice a further slight increase in tension just prior to release of the seat belt, which is entirely normal.

In the unlikely event that tension is not released after a manoeuvre is completed, bring the vehicle to a safe stop. Unbuckle and re-buckle the seat belt, which should then extract and retract normally, before continuing with the journey.



Seat belts should be worn by all vehicle occupants, for every journey, no matter how short.

If the **Active Seat Belts Unavailable** message and the yellow general warning symbol are displayed in the message centre, contact your Jaguar Dealer/ Authorised Repairer as soon as possible. The vehicle is still safe to drive and the Active Seat Belts will still function as standard seat belts.

CHILD SEATS



For optimum safety, children should travel in the rear of the vehicle at all times; front passenger seat travel is not recommended. However, if it is essential that a child travels in the front (not permitted in Australia), set the vehicle seat fully rearward and seat the child in an approved forward-facing child seat. Do not use a rear-facing child seat - an inflating airbag could impact with the seat and cause serious injury.





Do not use a forward facing child seat until the child using it is above the minimum weight of 9 kg (20 lb.) and able to sit up unaided. Up to the age of two, a child's spine and neck are not sufficiently developed to avoid injury in a frontal impact.



Do not allow a baby or infant to be held or carried on the lap. The force of a crash can increase effective body weight by as much as thirty times, making it impossible to hold onto the child.

Occupant safety

 **Children typically require the use of a booster seat appropriate to their age and size, thereby enabling the seat belts to be properly fitted, reducing the risk of injury in a crash. Children could be endangered in a crash if their child restraints are not properly secured in the vehicle.**

 **Do not use a child seat that hooks over the seat back. This type of seat cannot be satisfactorily secured and is unlikely to be safe for your child.**

The seat belts fitted to your vehicle are designed for adults and larger children. It is very important for all infants and children under 12 years of age to be restrained in a suitable child safety seat appropriate to their age and size.

If it is essential that a child travels in the front passenger seat (and national legislation permits this), Jaguar recommends that the following preparations are made before fitting the child restraint.

- Adjust the front passenger seat fully rearwards.
- Adjust the lumbar support to its minimum support position.
- Adjust the seat cushion to its highest position. If cushion front tilt adjustment is possible, adjust it to its lowest position.
- Adjust the seat back to the fully upright position.
- Adjust the seat belt adjustable upper anchorage to its lowest position.

 **Extreme hazard! Do not use a rearward facing child restraint on a seat protected by an airbag in front of it.**



E132397

This symbol, affixed to the end of the fascia on the passenger side, warns against the use of a rear-facing child seat in the front passenger seat, when a front passenger airbag is fitted and operational.

CHILD RESTRAINT CHECK LIST

Every time a child travels in the vehicle observe the following:-

- Use appropriate child restraints.
- Carefully follow the restraint system manufacturers instructions.
- Adjust the harnesses for every child on every trip.
- Ensure that all slack is removed from the adult seat belt.
- Always attach the top tether when installing an ISOFIX seat.
- Always check the security of the child restraint.
- Do not dress a child in bulky clothing, or place any objects/padding between the child and the restraint.
- Regularly check the fit and condition of child restraints. If the fit is poor, or wear/damage is visible replace the restraint immediately.
- Set a good example - always wear your seat belt.



Child restraint anchorages are designed to withstand only those loads imposed by correctly fitted child restraints. Under no circumstances are they to be used for adult seat belts, harnesses or for attaching other items or equipment to the vehicle.

BOOSTER SEATS

In a situation where a child is too large to fit into a child safety seat, but is still too small to safely fit the three point belt properly, a booster seat is recommended for maximum safety. Follow the manufacturer's instructions for fitting and use, then adjust the seat belt to suit.

CHILD SEAT POSITIONING



Information given within the table is correct at the time of going to press. However, availability of child restraints may change. Please consult your Dealer/ Authorised Repairer for the latest recommendation.

***Note:** The information contained in the following table may not be applicable to all countries. If you are in any doubt regarding the type and fitment of child seats seek advice from your Dealer/Authorised Repairer.*

Mass group	Seating positions		
	Front passenger*	Rear outboard	Rear centre
0 = Up to 10 kg (22 lb.) 0 to 9 months	X	U	U
0+ = Up to 13 kg (29 lb.) 0 to 18 months	X	U	U
I = 9 to 18 kg (20 to 40 lb.) 9 months to 4 years	UF	U	U
II = 15 to 25 kg (33 to 55 lb.) 4 to 9 years	U	U	U
III = 25 to 36 kg (55 to 80 lb.) 8 to 12 years	U	U	U

- **U** = Suitable for universal category restraints approved for this mass group.
- **UF** = Suitable for forward facing Universal category restraints approved for this mass group.
- **X** = Not suitable for child restraint fitment in this mass group.

* Jaguar recommend that the front passenger seat be positioned fully rearward, with the cushion adjusted to the highest position when installing child restraints.



***Note:** Ages given are approximate. In case of doubt, the child's weight, not age, should be used when considering an appropriate child seat.*



Crash statistics show that children are safest when properly restrained in a child or infant restraint system that is secured in a rear seating position.

Occupant safety

ISOFIX ANCHOR POINTS (not Australia)

-  Do not attempt to fit ISOFIX restraints to the centre rear seating position. The anchor bars are not designed to hold an ISOFIX restraint in this position.
-  If the restraint is not correctly anchored, there is a significant risk of injury to the child in the event of a collision or emergency braking.
-  If removing a head restraint in order to fit a child restraint, always secure the head restraint when storing it.

Both of the outer rear seat positions are equipped to accept ISOFIX restraints.



This symbol is shown on a label sewn into the seats to indicate the position of the ISOFIX lower anchorages.

Note: The information contained in the following table may not be applicable to all countries. If you are in any doubt regarding the type and fitment of child seats seek advice from your Jaguar Dealer/Authorised Repairer.

Mass group	Size classes	Fixtures	Rear outboard seats
Carrycot	F/G	ISO L1/L2	X
0 = Up to 10 kg (22 lb.) 0 to 9 months	E	ISO R1	IL*
0+ = Up to 13 kg (29 lb.) 0 to 18 months	C/D/E	ISO R1/R2/R3	IL*
I = 9 to 18 kg (20 to 40 lb.) 9 months to 4 years	C/D A/B1/B	ISO R2/R3 ISO F2/F2X/F3	X IUF
II = 15 to 25 kg (33 to 55 lb.) 4 to 9 years	-	N/A	N/A
III = 22 to 36 kg (49 to 80 lb.) 8 to 12 years	-	N/A	N/A

- **IUF** = Suitable for ISOFIX forward child restraint systems of universal category approved for use in the mass group.
- **IL** = These ISOFIX child restraint systems are of the specific vehicle, restricted or semi-universal categories.
- **X** = Not suitable for child restraint fitment in this mass group.
- ***** = Child seat suitable for use in these locations is the Britax/Römer Baby Safe Plus.

Note: Ages given are approximate. In case of doubt, the child's weight, not age, should be used when considering an appropriate child seat.

INSTALLING TETHER ANCHORAGE CHILD RESTRAINTS

1. Install the child restraint securely in one of the rear seating positions.
2. Pass the tether strap over the seat back and beneath the head restraint.
3. Attach the tether strap hook to the tether anchor point on the back of the seat. Ensure that the tether strap hook is facing the correct way. See item 7 in **24, USING SEAT BELTS AND CHILD SAFETY LOCKS**, **24, USING SEAT BELTS AND CHILD SAFETY LOCKS** .
4. Tighten the tether strap according to the manufacturer's instructions.

Occupant safety

AIRBAGS AND ACTIVE HEAD RESTRAINTS

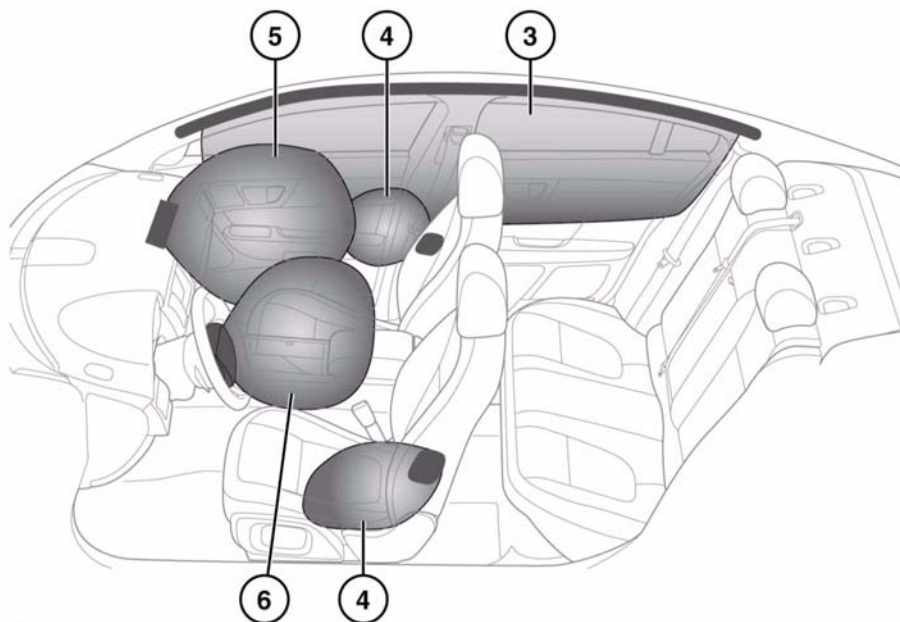
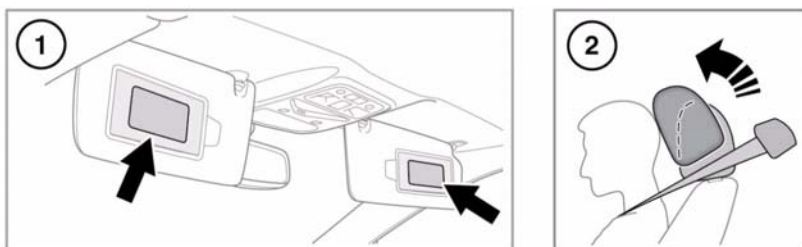

Euro NCAP

1. Airbag warning information is printed on the driver and passenger sun visors.
 2. Both front seats are equipped with Active Head Restraints (AHR), which reduce the risk of neck and spinal injury (whiplash) in the event of a rear impact, by moving the head restraint upwards and forwards, supporting the occupant's head.
 3. The curtain airbags may deflate at a slower rate than the front or side airbags, to afford prolonged protection.
 4. Seat mounted side airbags.
 5. Front passenger airbag.
 6. Driver's airbag.
- After activation, the whiplash protection mechanism resets automatically and does not need to be replaced.

Note: The general location of airbags fitted to the vehicle are marked by the word AIRBAG.

Always contact your Dealer/Authorised repairer if:

- An airbag inflates.
- The front or sides of the vehicle are damaged.
- Any part of the Airbag Supplementary Restraint System (SRS) shows signs of cracking or damage, including trim covering airbags.

AIRBAG OPERATION

 For the airbags to operate correctly the roof lining and door post trims must be in good condition, correctly fitted, and free from obstruction. Any damage, wear, or incorrect fitment should be referred to your Dealer/Authorised repairer as soon as possible for examination and repair.

 Do not obstruct the operation of the airbags by placing any part of their person or any objects in contact with, or close to, an airbag module. Only use approved accessories (e.g. seat covers).

 Ensure that a gap is maintained between the side of the vehicle, and the head and torso. This will enable unobstructed inflation of the curtain, and seat mounted side airbags.

 Airbags inflate at high speeds. To minimise the risk of injury, ensure that all vehicle occupants wear correctly positioned seat belts, sit correctly in the seats, and position the seats as far back as practical.



Airbag inflation takes place instantaneously, and cannot protect against the effects of secondary impacts. Under these circumstances the only protection will be provided by a correctly worn seat belt.



Phone systems should only be installed by qualified persons familiar with the operation of, and requirements for, vehicles fitted with SRS. If you are in any doubt, seek advice from your Dealer/Authorised repairer.

Airbag deployment is dependent on the rate at which the passenger compartment changes velocity following the collision. Circumstances affecting different collisions (vehicle speed, angle of impact, type and size of object hit, etc.), vary considerably and will affect the rate of deceleration accordingly.

The Supplementary Restraint System (SRS) components include:-

- SRS warning indicator.
- Rotary coupler.
- Airbag modules.
- Seat belt pre-tensioners (front seat belts).
- Airbag diagnostic control unit.
- Crash sensors.
- Airbag wiring harnesses.

The SRS is not designed to operate as a result of:

- Rear impacts.
- Minor front impacts.
- Minor side impacts.
- Heavy braking.
- Driving over bumps and pot holes.

Therefore, it follows that considerable superficial damage to the vehicle can occur, without causing the airbags to deploy.

SEAT BELT PRE-TENSIONERS

The seat belt pre-tensioners activate in conjunction with the Supplementary Restraint System (SRS) to provide additional protection in the event of a severe frontal impact. They automatically reduce any slack in a seatbelt to reduce forward movement of a front seat occupant.

 **The seat belt pre-tensioners will activate only once and then must be replaced. Failure to replace them will reduce the effectiveness of the SRS in reducing the risk of serious injury or death in the event of an accident.**

 **After any impact, have the seat belts and pre-tensioners checked and, if necessary, replaced by a Land Rover Dealer/Authorised Repairer.**

AIRBAG DEPLOYMENT EFFECTS

 **When an airbag inflates, a fine powder is released. This is normal and not an indication of a malfunction. The powder may cause irritation to the skin and should be thoroughly flushed from eyes and any cuts or abrasions.**

 **Airbag deployment is accompanied by a very loud noise which may cause discomfort and temporary loss of hearing.**

AIRBAG WARNING LAMP



The airbag warning indicator is mounted in the instrument panel, and will illuminate as a bulb check when the START/STOP button is switched on.



If the warning lamp indicates that a fault is present in the system, do not use a child restraint on the front passenger seat.

If any of the following warning indicator conditions occur, the vehicle should be checked by your Dealer/Authorised repairer immediately.

- The warning indicator fails to illuminate when the START/STOP button is initially switched on.
- The warning indicator fails to extinguish within six seconds of the START/STOP button being switched on.
- The warning indicator illuminates at any time other than during the bulb check.

AIRBAG SERVICE INFORMATION



Do not attempt to service, repair, replace, modify, or tamper with, any part of the SRS. This includes wiring or components in the vicinity of SRS components. Doing so may cause the system to trigger, or render the system inoperative.



Do not use any electrical test equipment or devices in the vicinity of SRS components or wiring. Doing so may cause the system to trigger, or render the system inoperative.

All of the following operations should only be carried out by a Dealer/Authorised Repairer, or suitably qualified person:-

- Removal or repair of any wiring or component in the vicinity of any SRS components.
- Installation of electrical, or electronic, equipment and accessories.
- Modification to the front or sides of the vehicle exterior.
- Attachment of accessories to the front or sides of the vehicle.

Exterior lights

LIGHTING CONTROL

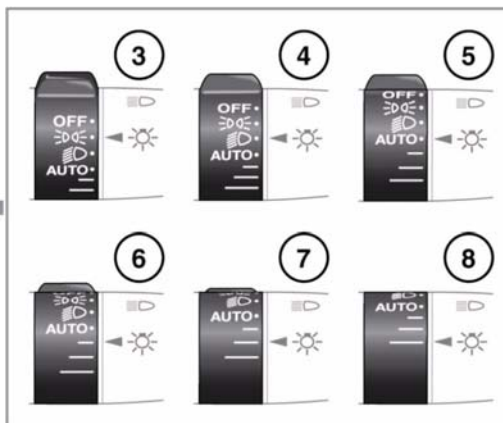

E132401

1. With the headlamps on, push the switch away from the steering wheel to select high beam. The blue warning indicator on the instrument panel will illuminate.
2. Pull the switch towards the steering wheel and release to flash the high beam. The high beam will remain on for as long as the switch is held.
3. Side lamps.
4. Headlamps.
Note: If the rotary control is moved to the **OFF** position with high beam selected, high beam will illuminate when the headlamps are turned on again.
5. Autolamps. With the ignition on, if ambient light fades the side lamps and headlamps will switch on automatically. If ambient light then increases, the side lamps and headlamps automatically go off.

Note: A light sensor on the front of the fascia monitors ambient light levels for autolamps operation. Keep the windscreen clean and ensure the sensor is not obscured. Obstructing the light in this area may lead to unwanted autolamps operation.

Note: If the autolamps are turned off, but the light sensors detect low exterior light levels, the warning **LIGHTS ARE OFF** is displayed in the message centre.

6. Exit delay of 30 seconds.
7. Exit delay of 60 seconds.
8. Exit delay of 120 seconds.

Note: Press the headlamp button on the Jaguar Smart Key to switch off the headlamps during an exit delay period.

DIRECTION INDICATORS

In addition to normal operation, the indicators will operate 3 times (e.g. to indicate a lane change) if the stalk is briefly pushed up or down.

DAYLIGHT RUNNING LAMPS

With the rotary control in the **OFF** or **AUTO** position, the front daylight running lamps will switch on automatically with the following conditions:

- The ignition is on.
- The engine is running.
- The gear selector is in **D** (Drive) or **R** (Reverse) - market dependent.

Note: *The lamps remain on if the gear selector is subsequently moved to **N** (Neutral)*

- The parking brake is not applied (is released) - market dependent.

APPROACH LAMPS

The headlamps can be illuminated remotely for a programmed length of time, by pressing the headlamp button on the Jaguar Smart key. See **4, UNLOCKING THE VEHICLE** . Press the button again to switch off.

Note: *In some markets, a second press will illuminate the reverse lamps and a third press is required to turn the lamps off.*

ADAPTIVE FRONT LIGHTING SYSTEM (AFS)

These lamps broaden the beam of the headlamps when cornering in different circumstances.

Static bending lamps: The static bending lamps operate when necessary, to provide an even broader light spread.

Cornering lamps: At speeds up to 40 km/h (25 mph), to provide improved visibility at junctions, the system switches on the lamp if it has received an input from the vehicle's direction indicator. Only the lamp on the same side as the operating indicator illuminates. The lamp will self cancel after 3 minutes of continuous operation.

WINDSCREEN WIPER DETECTION

This function only operates when autolamps is selected. The side lamps, tail lamps and headlamps will switch on automatically if the windscreen wipers are switched on for 20 seconds or more. Once the windscreen wipers are switched off, the side lamps, tail lamps and headlamps will automatically switch off 4 minutes later.

Exterior lights

AUTO HIGH BEAM

This feature automatically selects and deselects high beam, under specific conditions of road lighting and in the absence of other vehicle's lights. The system is only active when the ambient light drops below a predetermined level.

This function is only active if the rotary control is in the **AUTO** position and the stalk is in the central position.

The system will only activate when vehicle speed exceeds 25 mph (40 km/h). The system will deactivate when vehicle speed drops below 15 mph (24 km/h).

Note: Auto high beam does not operate when reverse gear is selected.

To manually select high beam, move the stalk to the high beam position as normal. To return to Auto high beam, move the stalk back to the central position.

To manually override to low beam from high beam, pull the stalk to the flash position and auto high beam will be cancelled. To return to auto high beam, push the stalk to the high beam position and then return it to the central position.



When auto high beam is enabled, the system indicator will illuminate.

Note: The following may affect the operation of auto high beam:-

- * Highly reflective road signs.
- * Vehicles with dim headlamps.
- * Adverse weather conditions.
- * Dirty sensor.
- * Dirty, damaged, or misted windscreen.

To turn off auto high beam, turn the rotary control from **AUTO** to headlamps on.

The Auto high beam feature can be disabled/ enabled via the security/ vehicle settings menu of the touch screen. See **61, VEHICLE SETTINGS**.

Note: Ensure that the sensor in the rear view mirror is not blocked or obstructed.

HEADLAMPS - CONDENSATION

In certain circumstances, misting may occur on the inside of a lamp lens. This is caused by natural changes in environmental conditions. This misting is not detrimental to lamp performance and will clear during normal usage.

INTERIOR LIGHTS

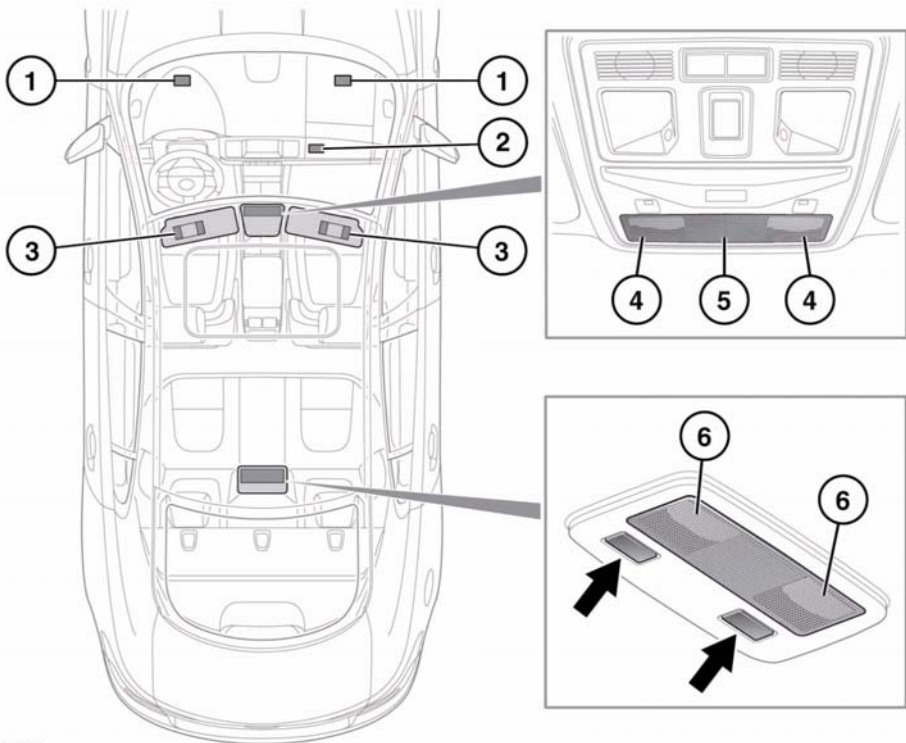

E134294

1. Front seat footwell illumination.
2. Glove box lamp.
3. Vanity mirror lamps.
4. Front reading lamps: Touch the lens briefly to switch on/off.
5. Front interior courtesy lamp: Illuminates when the doors are unlocked and extinguishes 30 seconds after all doors are closed or when the vehicle is locked.

The lamps are operated by proximity sensors. Move your finger close to (or touch) the appropriate lens to switch on/off. Touch the lens for 2 seconds to switch automatic illumination on/off (**Manual mode** or **Auto mode** is displayed in the message centre accordingly).

6. Rear interior and reading lamps: Switch on automatically when the doors are opened. Press the appropriate switch to activate a lamp manually

Wipers and washers

WIPER OPERATION

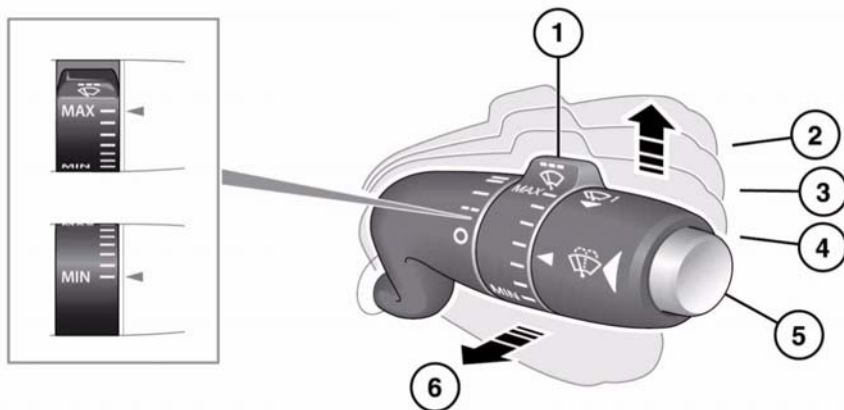

E132404

1. Rotate control to adjust sensitivity.
 - Rain sensor maximum sensitivity.
 - Rain sensor minimum sensitivity.
2. Fast speed wipe.
3. Normal speed wipe.
4. Rain sensor activated wipe.
5. Windscreen washer button.
6. Single wipe.

- ⓘ Do not operate the windscreen wipers on a dry screen.
- ⓘ In freezing or very hot conditions, ensure that the wipers have not stuck to the windscreen before operating.
- ⓘ Remove any snow, ice or frost from the windscreen, around the wiper arms and blades, and the screen scuttle, before operating the wipers.

Note: If the wiper blades become stuck or jammed, an electronic cut-out may temporarily halt wiper operation. If this happens, switch off the wipers and the ignition. Clear any obstructions and free the wiper blades, before attempting to switch on the ignition.

SPEED-DEPENDENT MODE

If vehicle speed drops below 2 km/h (1.2 mph) with the wipers operating, the wipers will switch to the next lowest speed. When vehicle speed increases to over 8 km/h (5 mph), the original wiper speed settings are restored.

RAIN SENSOR

- ⓘ Ensure that the wipers are switched off before entering a car wash. If the rain sensitive wipers operate during the car washing process damage may occur to the wiper mechanism.

The rain sensor is able to detect the presence and amount of rain, dirt or snow on the windscreen and automatically activates the windscreen wipers accordingly. Static droplets may not be detected on initial start-up, use a single wipe to clear the screen.

To activate the rain sensitive wipers, move the wiper stalk to the rain sensor position and adjust the rain sensor sensitivity control as required. When rain sensitive wipers are activated and when sensitivity is increased, a single wipe will operate.

WINDSCREEN WASHERS



Some screenwash products are flammable, do not allow screenwash to come into contact with sources of ignition.



Only screenwash products which are approved for automotive use should be used, and then only in accordance with the manufacturer's instructions.

To operate the wash/wipe, press and release the button on the end of the wiper stalk. The wipers will perform five normal speed wipes, followed by a drip wipe (if configured). The washers will operate during the first two wipes.

If the washers are operated with the wipers operating at normal or fast speed, the washer jets will operate for two wipes and operation of the wipers will not be affected.

Note: *If the button is pressed and held, the wipers and washers will operate at normal speed until the button is released (or for a maximum of 10 seconds).*

After the button is released, the wipers will operate for a further three wipes, followed by a drip wipe (if configured).

TIMED JET FUNCTION

If the timed jet function is configured, the washer jets will only operate on the up stroke of the wipers.



This function can be enabled/disabled by your Dealer/ Authorised Repairer.

DRIP WIPE

If the drip wipe function is configured, the wipers will operate four seconds after a wash/wipe cycle has finished, to clear any remaining drips from the windscreen.



This function can be enabled/disabled by your Dealer/ Authorised Repairer.

HEADLAMP WASHERS

Headlamp power wash operates automatically with the windscreen wash, and will only operate if the headlamps are switched on and there is sufficient washer fluid in the reservoir.

Headlamp wash operates with every fourth operation of the screen washers, provided that ten minutes have elapsed since the last operation of the headlamp washers.

Note: *The power wash sequence is reset when the headlamps or the ignition are turned off.*

Note: *Headlamp power wash is inhibited when the low washer fluid warning is on.*

Windows

ELECTRIC WINDOWS

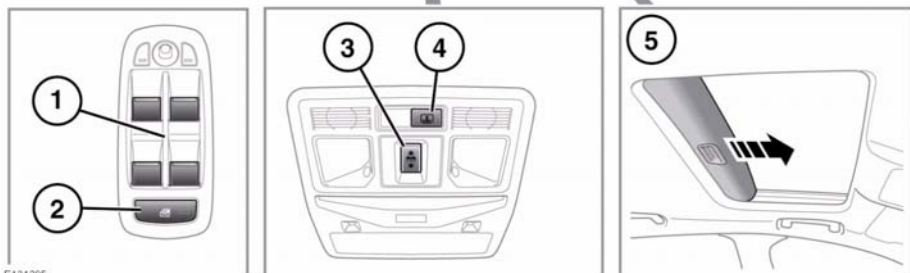
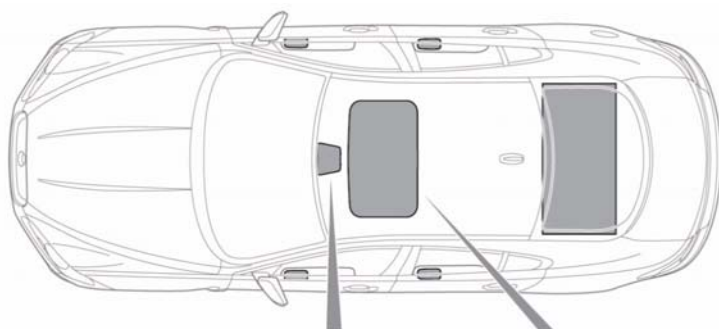

E134295

1. Window switches:

The windows will operate for 5 minutes after the engine is switched off, as long as none of the doors are opened.

2. Rear window isolator.



If children are carried in the rear seats, the isolator switch should be used to prevent operation of the windows.

3. Sunroof:

Roof movement can be halted at any time by pressing the button again.

If the sunroof encounters resistance when closing it will stop, and then open fully.

This is to prevent serious injury or damage to the mechanism.

- With the roof closed, briefly press the front of the switch to tilt the roof.
- With the roof closed, briefly press the rear of the switch to open the roof.
- With the roof open, briefly press the front of the switch to close fully.
- With the roof tilted, briefly press the rear of the switch to close.

4. Rear screen sun blind.

5. Sunroof blind:

The blind will open automatically when the roof is tilted or when the roof is fully opened. The blind can be opened manually when required, but can only be closed when the sunroof is closed.

ONE-TOUCH WINDOW OPERATION

The front windows have one-touch open operation. Briefly press the switch down fully and release, the window will lower until fully open.

The rear windows open in 2 stages:

- Briefly press the switch down fully and release; the window will open 65 - 75 mm (2.5 - 3 inches) to the comfort stop position.

Note: This position reduces resonance (booming sound) that can occur when driving with a front window open. Open the rear window on the same side of the vehicle as the open front window, to reduce resonance.

- Briefly press the switch down fully and release a second time, to fully open the window.

The front and rear windows also have one-touch close operation. Briefly pull the switch up fully and release, the window will rise until fully closed.

Pressing or pulling the switch again will stop a window in one-touch operation.

WINDOW ANTI-TRAP PROTECTION



Before closing a window, ensure that no occupants have any part of their body in a position where it could be trapped. Even with an anti-trap system death or serious injury could occur.

Anti-trap protection is designed to stop window movement if an obstruction or resistance is detected. Check the window and its aperture and remove any obstructions. The override procedure is as follows:-

1. Attempt to close the window. Anti-trap will prevent closure and lower the window.

2. Within 10 seconds, attempt to raise the window again. Anti-trap will prevent closure and lower the window.
3. Attempt to close the window for a third time, this time holding the switch in the close position. The window will raise whilst the switch is held. Hold until closed.

Note: If this procedure fails to remove the blockage, or if the windows do not operate correctly, the window operation may need to be reset. See **164, WINDOW RESET.**

SUNROOF ANTI-TRAP MECHANISM



Before closing the sunroof, ensure that no occupants have any part of their body in a position where it could be trapped. Even with an anti-trap system death or serious injury could occur.

The anti-trap mechanism can be overridden to allow the roof to be closed when movement is restricted by dirt. To override the anti-trap mechanism, press and hold the front of the switch until the roof reaches the closed position.

If the sunroof fails to operate correctly, it may need to be reset. See **164, SUNROOF RESET.**

Mirrors

EXTERIOR MIRRORS

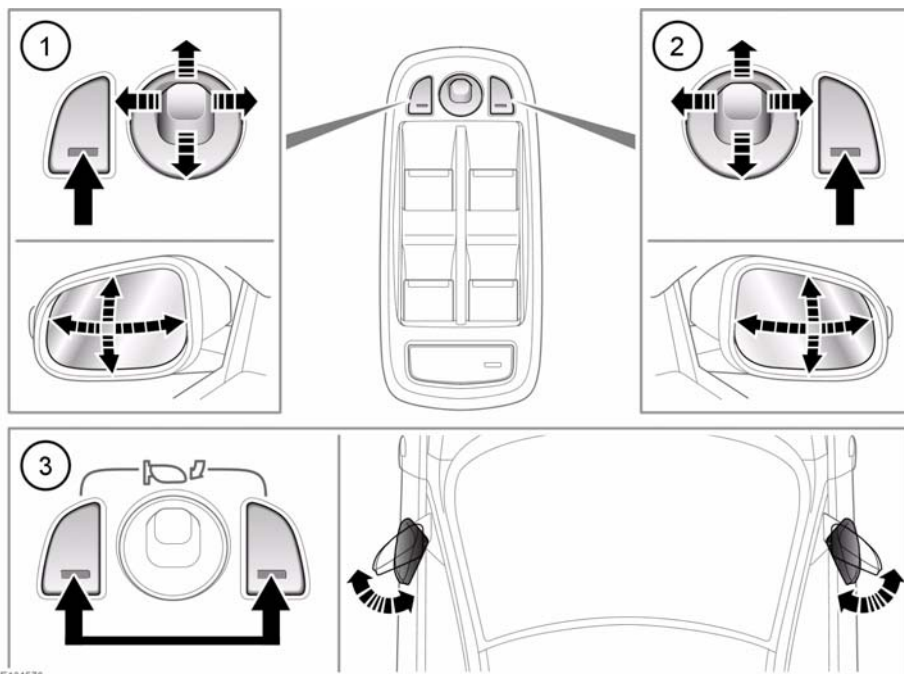

1. Left mirror adjustment.
2. Right mirror adjustment.
3. Powerfold/Unfold: Press both buttons simultaneously. This feature is inhibited at speeds over 110 km/h (70 mph).

The mirrors can be adjusted and folded when the ignition is on and for up to 5 minutes after the ignition is switched off, provided the driver's door is not opened.

Press the appropriate button to select the mirror to be adjusted (button indicator illuminates), then use the joystick control to adjust the mirror glass.

Note: Depending on the type of lens used, distances may be difficult to judge accurately when only using the mirrors.

The mirrors can be configured to automatically fold when the vehicle is locked and unfold when unlocked. This feature can be enabled or disabled via the Security/vehicle settings area of the touch screen. See **61, VEHICLE SETTINGS**.

If the mirrors are accidentally knocked out of position (i.e. so only one is folded), press both buttons simultaneously to resynchronise.

Note: If the mirrors were folded using the switches, they will not unfold when the vehicle is unlocked.

Note: Two different exterior mirror positions can be stored and recalled using the driving position memory feature. See **15, DRIVING POSITION MEMORY**.

MIRROR DIP WHEN REVERSING

The mirrors can be configured so that when reverse gear is selected, the passenger door mirror automatically adjusts to provide an improved viewing angle for reversing.

The exact dipped position can be adjusted using the joystick control, when the mirror is dipped. The next time reverse is selected, the newly adjusted position will be selected.



When the gear selector is moved out of reverse, or if vehicle speed exceeds 12 km/h (7.5 mph) while reversing, the mirror will return to its previous position.



Mirror dip can be selected or deselected using the touch screen, as follows:

- From the touch screen Home menu, select **Set-up**.
- Select **Security/vehicle**.
- Select **Windows/mirrors**.
- Select **Reverse mirror dip - On or Off**.

Blind spot monitoring

BLIND SPOT MONITOR

-  The Blind Spot Monitor (BSM) system is a supplement to, not a replacement for, a safe driving style and use of the exterior and rear-view mirrors.
-  Please note that BSM may not be able to give adequate warning of vehicles approaching very quickly from behind or vehicles that are being overtaken rapidly.
-  BSM may not be able to detect all vehicles and may also detect objects, such as roadside barriers, etc.

-  The radar sensors may be impaired by rain, snow or road spray. This may affect the system's ability to reliably detect a vehicle/object within the blind spot.
-  Ensure that the warning indicators in the exterior mirrors are not obscured by stickers or other objects.
-  Do not attach stickers or objects to the rear bumpers, that may interfere with the radar sensors.

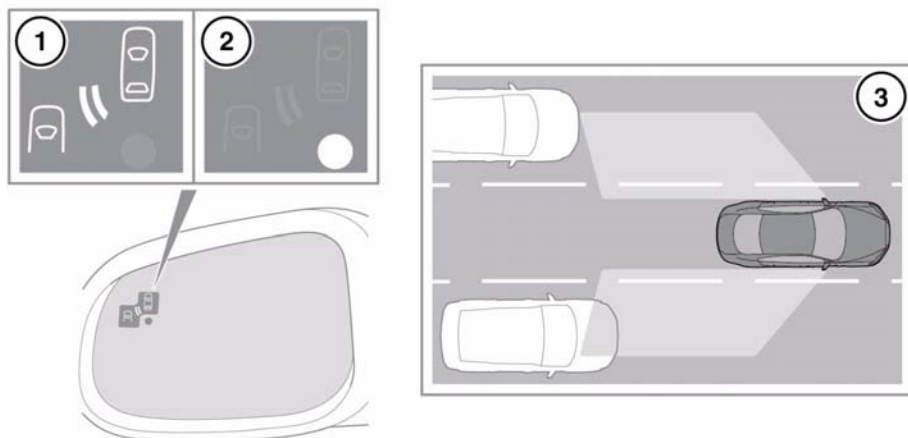

E132412

The Blind Spot Monitor (BSM) system monitors a zone that covers the area adjacent to the vehicle, that is not easily visible by the driver and is designed to identify any object overtaking the vehicle (3). The system uses a radar on each side of the vehicle to identify any overtaking vehicle/object within the blind spot area of the vehicle, while disregarding other objects which may be stationary or travelling in the opposite direction, etc.

If an object is identified by the system as being an overtaking vehicle/object, an **amber** warning icon (1) illuminates in the relevant exterior mirror, to alert the driver that there is a potential hazard in the vehicle's blind spot and therefore, that a lane change might be dangerous.

The radar monitors the area extending from the exterior mirror rearwards, to approximately 6 metres (20 feet) behind the rear wheels, and up to 2.5 metres (8.2 feet) from the side of the vehicle (the width of a typical carriageway lane).

Note: This radar sensor is approved in all RTTE countries.

Note: The system covers an area of a fixed lane width. If the lanes are narrower than a typical carriageway lane, objects travelling in non-adjacent lanes may be detected.

BSM automatically switches on and becomes active when the vehicle is travelling at more than 16 km/h (10 mph) in a forward gear.

When the system initiates, it performs a self-check, during which the warning icons in the mirrors illuminate alternately for a short period of time.

The indicator dot (2) remains illuminated until forward vehicle speed exceeds 16 km/h (10 mph).

BSM is designed to work most effectively when driving on multi-lane highways.

Note: If an overtaking vehicle is detected on both sides of the vehicle simultaneously, the warning icons in both mirrors will illuminate.

Note: BSM is automatically turned off when reverse (R) gear is selected, when the vehicle is in park (P), the vehicle is travelling below 16 km/h (10 mph). Under these conditions, an amber warning indicator within the exterior mirror is displayed.

SENSOR BLOCKAGE

The BSM system will automatically disable if either of the sensors become completely obscured, an amber warning indicator dot (2) is displayed in the exterior mirror and the message **BLIND SPOT MONITOR SENSOR BLOCKED** appears in the message centre.

Note: Blockage testing is only initiated when vehicle speed is above 32 km/h (20 mph) and will take at least two minutes of accumulated driving above this speed, to determine that the sensor is blocked.

If the sensors become blocked, then please check that there is nothing obscuring the rear bumper and that it is clear from ice, frost and dirt.

BSM SYSTEM FAULT



If a fault with one of the radar sensors is detected, an amber warning indicator dot is displayed in the exterior mirror and the message **BLIND SPOT MONITOR NOT AVAILABLE** is displayed in the message centre.

Note: Even if the detected fault only affects the radar sensor on one side of the vehicle, the whole system is disabled. If the fault is temporary, the system will operate correctly once the engine has been switched off and then on again.

If a fault in the system occurs, consult your Dealer/Authorised Repairer.

Garage door opener

GARAGE DOOR TRANSCEIVER

-  **Do not use the transceiver with any garage door opener that lacks the safety stop and reverse feature as required by safety standards.**
-  **When programming the transceiver to a garage door opener or entry gate, ensure the area is clear. This will prevent potential harm or damage as the gate or garage door will activate during the programme.**
-  This device may suffer from interference if operated in the vicinity of a mobile or fixed station transmitter. This interference is likely to affect the hand-held transmitter as well as the in-car transceiver.

The door transceiver is located in the rear-view mirror. It can be programmed to transmit the radio frequencies of up to three different transmitters, which can be used to operate garage doors, entry gates, home lighting, security systems or other radio frequency operated devices.

Although this section mainly describes the procedures for a garage door opener, it equally applies to the previously mentioned applications.

In some countries, this feature is also known as the HomeLink® Universal Transceiver.

For further information, see **50, INFORMATION AND ASSISTANCE.**

BEFORE PROGRAMMING

-  When programming a device that may require you to press and re-press the hand-held transmitter (cycle), unplug the device during the cycling process to prevent possible motor failure.

For best results, fit a new battery to the hand-held transmitter of the garage door opener (or other device) before programming. If your garage door opener receiver (located in the garage) is equipped with an antenna, ensure that the antenna is hanging straight down.

PROGRAMMING



Ensuring that the engine is switched off:

1. Ensure that the ignition system is on.
2. Hold the end of the original garage door opener hand-held transmitter 50 to 150 mm (2 to 6 inches) away from the transceiver in the rear-view mirror, keeping the indicator lamp in view.
3. Using both hands, simultaneously press and hold both the chosen transceiver button on the rear-view mirror, as shown above, and the hand-held transmitter button. Keep both buttons pressed. The indicator lamp will flash slowly at first and then change to a fast flash. When the indicator lamp flashes rapidly, release both buttons. The rapid flashing lamp indicates successful programming.

4. If, after 60 seconds, the indicator lamp does not flash rapidly, release both the transceiver and the hand-held transmitter buttons and repeat the procedure starting with Step 2. Position the hand-held transmitter at a different angle and/or distance.
5. Press and hold the programmed garage door opener button and observe the indicator lamp.
 - If the indicator is continuous, programming is complete and your device should operate when the garage door opener button is pressed and held for approximately 1 to 2 seconds and then released.
 - If the indicator lamp blinks rapidly for two seconds and then illuminates continuously, proceed with the following programming instructions for rolling code device equipment.

TO ERASE ALL PROGRAMMING

For first time programming, ensure that the engine is switched off:

1. Ensure that the ignition system is in convenience mode (see 7, **CONVENIENCE MODE**).
2. Press and hold the two outer buttons on the transceiver in the rear-view mirror. Keep the buttons pressed until the indicator lamp begins to flash (this will take approximately 20 seconds), then release the buttons.

All memories in the garage door opener have now been cleared.

Note: Do not perform this procedure when programming the additional garage door opener buttons.

ROLLING CODE DEVICE EQUIPMENT PROGRAMMING

Note: The assistance of a second person, may make the following steps quicker and easier. Once the button has been pressed there are only 30 seconds in which to complete Step 3.

1. At the garage door opener receiver (motor head unit) in the garage, locate the learn or smart button/switch.
 - The name of the button or switch may vary between manufacturers.
2. Press and release the learn or smart button.
3. Return to the vehicle and firmly press and hold the programmed garage door opener button for two seconds and release.
4. Repeat the press, hold, release sequence three times to complete the programming process.

The garage door opener in the rear-view mirror should now activate the rolling code device.

REPROGRAMMING A SINGLE GARAGE DOOR OPENER BUTTON

To programme a device to a previously programmed button:

1. Press and hold the desired pre-programmed garage door opener button for at least 20 seconds, but no longer than 30 seconds, until the indicator lamp begins to flash.
2. Without releasing the rear-view mirror button, position the hand-held transmitter approximately 50 to 150 mm (2 to 6 inches) away from the transceiver in the rear-view mirror, keeping the indicator lamp in view.
3. Carry out Step 3 of **Programming**.

Garage door opener

ENTRY GATE PROGRAMMING

The technology of some entry gates requires you to press and re-press (cycle) the hand-held transmitter button every two seconds during programming.

Continue to press and hold the desired rear-view mirror button while you cycle your hand-held transmitter until the indicator lamp flashes rapidly.

INFORMATION AND ASSISTANCE



It is recommended that when you sell or dispose of the vehicle, the programmed transceiver buttons be erased for security purposes.

For information on the range of available compatible products or accessories, or for assistance, you should contact your Dealer/ Authorised Repairer.

You can also contact the supplier's helpline on 0 800 04663 5465. This toll-free number can be called from anywhere within Europe. No separate country code is required (the first zero is not required when calling from within Germany).

Contact can also be made via the internet. The website address is www.eurohomelink.com.

The e-mail address is info@eurohomelink.com.

Note: *Keep the original transmitter for future use or programming procedures if, for example, you purchase a new vehicle.*

Note: *The manufacturer is not responsible for any radio or TV interference caused by unauthorised modifications to this equipment. Such modifications could void the user's authority to operate the equipment.*

WARNING LAMPS AND INDICATORS

RED warning lamps are for primary warnings. A primary warning must be investigated immediately, seek qualified assistance if necessary.

AMBER warning lamps are for secondary warnings. Some indicate that a vehicle system is in operation, others indicate that the driver must take action and then seek qualified assistance as soon as possible

Other warning lamps within the instrument panel indicate system status, such as blue for main beam and green for direction indicators, when in operation.

LAMP CHECK

A warning lamp bulb check is initiated when the ignition system is switched on and lasts for 3 seconds (except for the airbag warning lamp which will remain on for 6 seconds). If any warning lamp remains on after this period, investigate the cause before driving.

Some warning lamps have associated messages displayed on the message centre.

Note: *Not all warning lamps are included in the check (e.g. high beam headlamps and direction indicators).*

BRAKE (RED)



Do not drive if the message LOW BRAKE FLUID is displayed. Check the brake fluid level and top-up as necessary. If necessary, seek qualified assistance before continuing.



Illuminates when the ignition is on and the parking brake is applied and/or the brake fluid is low. The warning lamp will also illuminate when there is a fault with the Electronic Brakeforce Distribution (EBD) system.

If the warning lamp is on and there are no associated messages, it means that the parking brake is on.

If the warning lamp is illuminated and the message **PARK BRAKE ON** is displayed, it means that the parking brake is applied but the vehicle is moving. Release the parking brake or stop the vehicle when it is safe to do so.

If the lamp is illuminated and the message **LOW BRAKE FLUID** is displayed, loss of braking in one or both brake circuits may be imminent. Stop the vehicle gently and check and top-up the brake fluid reservoir, using the recommended fluid. If the warning message remains, do not drive the vehicle until the brake fault is rectified. Seek qualified assistance before continuing.

If the lamp illuminates and the message **EBD FAULT** is displayed in the message centre, a fault with the EBD system is indicated. The braking system will still function, but without EBD assistance.

Have the fault rectified by your Dealer/ Authorised Repairer.

Warning lamps

SEAT BELT (RED)



The warning lamp stays illuminated when the ignition is on and:

- The driver's seat belt is not fastened.
- Or a passenger is sitting in the front seat and their seat belt is not fastened.

The lamp should extinguish when the relevant seat belt is fastened.

BELTMINDER (RED)



The belt minder feature, which uses the same warning lamp as the seat belt warning, provides reminders to the driver that the driver's and/or front passenger's seat belt is unbuckled.

If the vehicle is moving at or above 16 km/h (10 mph) and the seat belt of an occupied front seat is not fastened, the warning lamp will flash.

The flashing will last for 10 seconds and then repeat every 10 seconds for approximately 5 minutes or until the belt(s) is fastened or the vehicle stops.

If the warning lamp stays illuminated with the seat belt(s) fastened, seek qualified assistance as soon as possible. It is safe to drive the vehicle with the lamp illuminated, provided that the seat belt(s) is properly fastened.

Ensure that all occupants fasten their seat belt before driving.

Note: *If a heavy object is placed on the front passenger seat, it may activate the Beltminder feature. It is recommended that the object be placed in the luggage compartment.*

ANTI-LOCK BRAKING SYSTEM (ABS) (AMBER)



If the ABS and brake warning lamps are illuminated at the same time, do not drive the vehicle until the fault is rectified. Seek qualified assistance immediately.



Illuminates if a fault has been detected in the ABS (accompanied by a warning message in the message centre).

The brake system will continue to function, but without ABS assistance.

If the warning lamp illuminates or stays illuminated after the bulb check cycle, seek qualified assistance as soon as possible.

ENGINE MALFUNCTION (AMBER)



Illuminates when the ignition is on and remains illuminated until the engine is started.

If the lamp illuminates when the engine is running, there is an engine malfunction.

Specialised diagnostic equipment is required to repair such faults. Seek qualified assistance as soon as possible.

The vehicle can still be driven, but may activate limp-home mode, with the possibility of reduced engine performance.

DYNAMIC STABILITY CONTROL (DSC) (AMBER)



Flashes when DSC is active.

If there is a fault, this warning lamp will illuminate in the instrument panel and the message centre will display **DSC NOT AVAILABLE**.

The vehicle can still be driven, but the DSC system will not activate under wheel spin or slide conditions. You should seek qualified assistance as soon as possible.

If Trac DSC is selected, the warning lamp will also illuminate and the message **TRAC DSC** is displayed for 4 seconds.

DYNAMIC STABILITY CONTROL (DSC) OFF (AMBER)



Illuminates when DSC is switched off. A chime will also sound and the message DSC OFF is displayed in the message centre.

REAR FOG LAMPS (AMBER)



Illuminates when the rear fog lamps are switched on.

ADAPTIVE CRUISE CONTROL (AMBER)



Illuminates when adaptive cruise control is active, to indicate that the vehicle is in follow mode.

FORWARD ALERT (AMBER)



Illuminates when forward alert is active.

AIRBAG (AMBER)



Illuminates if the airbag system develops a fault. Seek qualified assistance as soon as possible.

AUTOMATIC SPEED LIMITER (AMBER)



Illuminates when Automatic Speed Limiter is active.

ADAPTIVE FRONT LIGHTING SYSTEM (AMBER)



Illuminates when there is a system fault. The headlamps will still operate, but without this feature operating correctly. Seek qualified assistance as soon as possible.

TYRE PRESSURE MONITORING SYSTEM (YELLOW)



Illuminates when one or more tyres are significantly under-inflated. The vehicle should be stopped as soon as possible and the tyres checked and inflated to the recommended pressure.

Warning lamps

HIGH BEAM (BLUE)



Illuminates when the high beam headlamps are switched on or flashed.

AUTO HIGH BEAM (GREEN)



Illuminates when auto high beam is enabled.

ECO STOP/START (GREEN)



Illuminates when the engine is shutdown by the Eco Stop/Start system.

Note: Other warnings normally associated with an engine shutdown, for example the ignition warning lamp, do not illuminate during an engine shutdown by the Eco Stop/Start system.

SIDE LIGHTS (GREEN)



Illuminates when the side (parking) lamps are switched on.

DIRECTION INDICATORS (GREEN)



The appropriate warning lamp will flash when the column stalk is moved up or down to signal a turn. If a direction indicator bulb fails, the audible ticking and warning lamp will sound and flash at twice the normal rate, when that direction indicator is selected.

AUDIBLE WARNINGS AND INDICATORS

Hazard or Condition	Chime or tone/remedy
External lamps remain on when the driver's door is opened.	A chime will sound until the lamps are switched off or driver's door is closed (unless the lighting control is in AUTO position).
Hazard warning indicators on.	A ticking will sound until the hazard indicators are switched off.
Direction indicators on.	A ticking will sound until the indicators are switched off.
Memory 1 (or 2) settings saved.	A short tone as the memory selection is saved.
Seat belt reminder.	A chime will sound if a seat belt is unbuckled whilst the vehicle is moving. The warning will cease if the occupied seat's belt is re-buckled, the ignition is turned off or more than 3 minutes has elapsed.
Electric parking brake (EPB).	If the EPB is applied while the vehicle is moving a continuous chime will sound; release the EPB. If there is a fault with the system which would prevent the application of the EPB, a brief sequence of chimes is initiated.
Adaptive Cruise Control (ACC) driver intervene.	Multiple chime. Apply the brakes.
ACC low speed automatic switch off.	A chime will sound to indicate that the ACC system is no longer operating.
Speed is over 15 km/h (9 mph) above the set limit speed.	A short warning chime. Reduce speed.
Gear selector is not in Park with ignition off.	A chime will sound. Select Park.
Entry delay warning (European markets only).	Intermittent slow, low pitched chime. Disarm vehicle.
The Jaguar Smart Key cannot be detected.	A chime will sound. The Smart Key should be docked in the starter control unit. See 76, IF THE ENGINE FAILS TO START .
The Jaguar Smart Key is to be removed from the starter control unit.	A chime will sound for 60 seconds if the Smart Key is in the starter control unit and the driver's door is opened. The remote handset should be undocked from the starter control unit. See 76, IF THE ENGINE FAILS TO START .
DSC OFF	A chime will sound.

WARNING AND INFORMATION MESSAGES



Do not ignore warning messages. Take appropriate action and, when necessary, seek qualified assistance before driving the vehicle.

If more than one message is active, each is displayed in turn for 2 seconds in order of priority.

Note: *The message centre messages and their meanings, are detailed where necessary within the appropriate subject sections.*

TRIP COMPUTER

The computer memory stores data for a journey or series of journeys until it is reset to zero.

The displayed information is for guidance only, as it can be affected by traffic, road and weather conditions.

Three independent memories are available, A, B and Auto. A and B memories can be reset independently, while the Auto trip will reset after every ignition cycle as the vehicle moves.

Trip computer information is displayed on the instrument panel.

USING THE TRIP COMPUTER

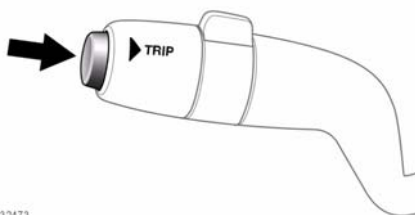

E132473

Press the **TRIP** button on the end of the left column stalk repeatedly to display the trip data in the following order:

- ODO + Trip Distance Range.
- Range.
- Average Fuel Consumption.
- Average Speed.
- Oil Level (not V6 diesel).
- Digital Speed.

To reset the displayed trip data, press and hold the **TRIP** button.

TRIP DISTANCE

Distance travelled since the last memory reset. The maximum trip reading is 9 999.9 (kilometres or miles). The computer will automatically reset to zero if this distance is exceeded.

RANGE

This shows the predicted distance, miles or kilometres, that the vehicle should travel on the remaining fuel, assuming fuel consumption stay constant.

METRIC/IMPERIAL/MIXED DISPLAY

The display of metric, imperial or mixed units is selected via the touch screen:

- With the touch screen switched on, select **Set-up** from the Home menu.
- Select **Security/vehicle**, then select **Units**.
- Touch the appropriate button to select Metric or Imperial units.

***Note:** Temperature display can be changed between °C (Celsius) and °F (Fahrenheit) independently of Metric or Imperial units.*

SERVICE INTERVAL INDICATOR

The service interval message will only be displayed when the vehicle has less than 3200 km (2000 miles) before the service is due.

When the ignition is switched on, and the vehicle has started its service countdown, **SERVICE REQ'D XXXX km (XXXX MLS)** is displayed in the message centre.

When the service distance has been reached, **SERVICE REQUIRED** is displayed in the message centre.



If no service interval indicator is displayed during the vehicle service cycle, make sure that your vehicle is serviced in accordance with the intervals, as stated in the Service Portfolio.

Touch screen

TOUCH SCREEN HOME MENU

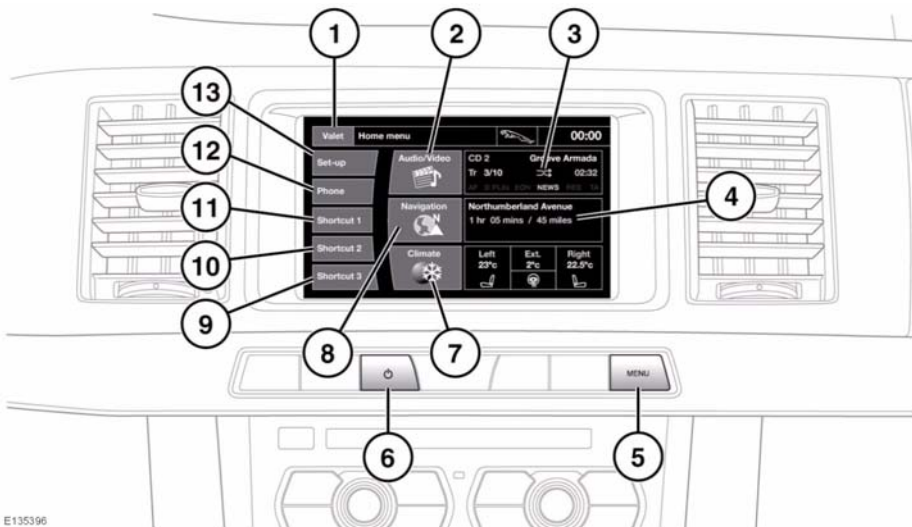

E135396

1. Touch to select **Valet** mode.
Note: To enter/exit Valet mode, the correct PIN will need to be entered. See **61, SELECTING VALET MODE.**
2. Touch to view the **Audio/Video** menu.
3. An overview of current audio information is shown on the Home menu.
4. An overview of current navigation information is shown on the Home menu.
5. Press to return the touch screen to the Home menu.
6. Press to turn the touch screen on or off.
Note: Not fitted on vehicles with Eco Stop/Start. Touch screen turns on and off with ignition.
7. Touch to view the touch screen **Climate** menu. Internal front left and right temperature settings, external temperature and heated steering wheel control are also shown on the Home menu.
8. Touch to select the **Navigation** menu.
9. Short cut key. Use for personal short cuts to any part of the system. Short cuts can be made in the **Set-Up Menu.**
10. Short cut key. Use for personal short cuts to any part of the system. Short cuts can be made in the **Set-Up Menu.**
11. Short cut key. Use for personal short cuts to any part of the system. Short cuts can be made in the **Set-Up Menu.**
12. Touch to view the **Phone** menu.
13. Touch to select the vehicle **Set-up** menu, to adjust touch screen, system, voice, trip computer and security/vehicle settings.

TURNING OFF THE TOUCH SCREEN

Vehicles without Eco Stop/Start:

1. Press the screen on/off button once to activate the screensaver (see **58, TOUCH SCREEN HOME MENU**). If the screensaver has not been set, a single press will turn off the touch screen.
2. Press the screen on/off button twice to turn off the touch screen.
3. To turn on the touch screen, press the screen on/off button.

Vehicles with Eco Stop/Start:



1. From the **Home menu**, touch the screen off soft key to activate the screensaver. If the screensaver has not been set, touching the screen off soft key will turn off the touch screen.
2. From the screensaver, touch the screen off soft key to turn off the touch screen.
3. To turn on the touch screen, touch anywhere on the screen.

TOUCH SCREEN USE



Always run the engine during prolonged use of the touch screen.

The buttons on the centre console, below the touch screen display, are referred to as **hard buttons** and should be pressed firmly. The touch screen buttons are referred to as **soft keys** and only require light pressure to function. Do not use excessive pressure.

TOUCH SCREEN DISPLAY ICONS

Touch screen display icons are as follows (they may not all be displayed at the same time):



Audio/Video: Touch to select the Audio/Video menu.



Climate: Touch to select the Climate control menu.



Navigation: Touch to select the Navigation menu.



Back soft key: Touch to return to the previous screen displayed.



Shows the current status of the relevant heated/ventilated seat.



Shows the current status of the steering wheel heater.

TOUCH SCREEN CARE



Do not use abrasive cleaners on the touch screen. For approved cleaning products, contact your Dealer/ Authorised Repairer.

TOUCH SCREEN SETUP

- Select **Set-up** from the Home menu.

The setup screen contains five settings categories:

- Screen
- System
- Voice
- Trip computer
- Security/vehicle

Touch screen

SCREEN SETTINGS

Screensaver: Select to change the screensaver. Touch an option to select.

Screen animations: Select to turn animated transitions between screens on or off.

Note: While screen animations are on, system response time will be slower than normal.

Time out home: Sub menu selection screens can be set to revert to the **Home** menu after a pre-determined length of time.

Theme: Changes appearance of the touch screen soft keys.

SYSTEM SETTINGS

Button feedback: Select to turn the soft key confirmation tone on or off.

Clock adjust: Select 12 or 24 hour clock. Set current time. Select **Date** to change the date, or to alter the date format. Select **Set**, to store new settings.

Note: The clock can also be adjusted from the touch screen time display.

Home menu shortcuts: Select up to three items from the displayed list to appear as shortcuts on the **Home menu**. Select **Clear** to deselect highlighted items.

Language: Select the required language. Select **Male** or **Female** voice. Touch **Change** to select alternatives for Voice and text displays. Follow the on-screen instructions to confirm.

Note: Some languages are not yet available for both System display text and Voice control. In this event, it will be necessary to select a separate language for Voice control.

Volume presets: Adjust volume for the available systems (announcements, phone, voice etc.).

VOICE SETTINGS

- **Command list:** View the categories and the acceptable voice commands.

Select an **Information** button to view alternative function commands.

- **Voicetags:** View the categories. Select a category to manage the voicetags for the chosen system. See **127, VOICETAGS**.
- **Operating guide:** View brief Voice system instructions. Select **Voice tutorial** for more detailed instructions (cancel via the displayed pop-up or by pressing and holding the voice button).
- **Preferences:** Select to alter the following settings:
 - **Voice profile:** The voice system can be trained to have a greater recognition of a particular voice or accent. The default setting is **Standard**. To build a voice profile for either **User 1** or **User 2**, it is necessary to complete a training program first.
To complete the training for the first time, select either **User 1** or **User 2** and follow the on-screen and audible instructions.
 - **Voice feedback:** Select **On** or **Off**.
 - **Feedback volume:** Adjust using the +/- buttons. It is not possible to reduce the volume to zero.
- **Voice training:** Select to access the voice system training program, designed to enable the system to better recognise the vocal characteristics of a user.
Select **User 1** or **User 2** and follow the on screen and audible instructions. See **127, VOICE TRAINING**.

The training session can be cancelled at any time by touching the on-screen pop-up or by pressing and holding the Voice button on the steering wheel. See **126, USING VOICE CONTROL**.

TRIP COMPUTER SETTINGS

Trip Computer: Select to switch trip computer readings between **Trip A**, **Trip B** and **Trip Auto**. Select **Reset** to zero the trip computer readings. Select **Units** to switch the trip computer readings between Imperial and Metric measurements.

VEHICLE SETTINGS

- **Security:** Select to enable/disable or alter the settings of the following:

- Single/multi-point entry (2 stage unlocking).
- Alarm sensors (interior and tilt).
- Drive-away locking.

Scroll down through the menu until the desired feature is displayed, then select **On** or **Off**, as appropriate.

If drive-away locking is switched on, select the desired speed (8, 16 or 32 km/h or 5, 10 or 20 mph).

- **Windows/mirrors:** Select to enable/disable:
 - Global opening/closing of windows and sunroof.
 - Exterior mirror dip when reversing.
 - Automatic folding/unfolding of exterior mirrors when vehicle is locked/unlocked.
 - Interior mirror dimming.

Scroll down through the menu until the desired feature is displayed, then select **On** or **Off**, as appropriate.

- **Units:** Select to switch between Imperial and Metric measurements.
- **Auto (AHB) high beam:** Select to turn AHB on or off, and set AHB for side of road being driven on.

SELECTING VALET MODE

Valet mode allows the vehicle to be locked by a parking attendant, without giving access to the luggage compartment and glove box. Valet mode also prevents operation of the touch screen, to prevent access to telephone numbers or navigation addresses.

From the **Home** menu, select **Valet**, then enter a four digit Personal Identification Number (PIN) (personally chosen). You will then be prompted to re-enter the same PIN. On completion, touch the **OK** soft key.

If you wish to cancel the PIN, touch the **C** soft key. If the PIN is cancelled, or incorrectly entered, you will be prompted to enter the PIN again.

Once the PIN has been correctly entered, a security information pop-up is displayed. Read the information and remove the emergency key from the Jaguar Smart Key.

Valet on is displayed to indicate that the PIN has been accepted. The luggage compartment and glove box are now securely locked in Valet mode.

On exiting and securing the vehicle, remove the emergency key from the Jaguar Smart Key. Retain the emergency key and give the Jaguar Smart Key to the attendant.

Note: *The emergency key can be used to open the luggage compartment, which may de-activate Valet mode.*

DESELECTING VALET MODE

When you enter the vehicle, select the Valet mode screen.

Enter your four digit PIN and touch the **OK** button. A pop-up is displayed. Read the information and stow the emergency key in the Jaguar Smart Key.

Valet off is displayed to indicate that your PIN has been accepted.

- The luggage compartment will return to the previously set security requirement.
- The glove box will now open as normal.

Note: *If the PIN is forgotten, open the luggage compartment using the emergency key blade to cancel Valet mode.*

CLIMATE CONTROL

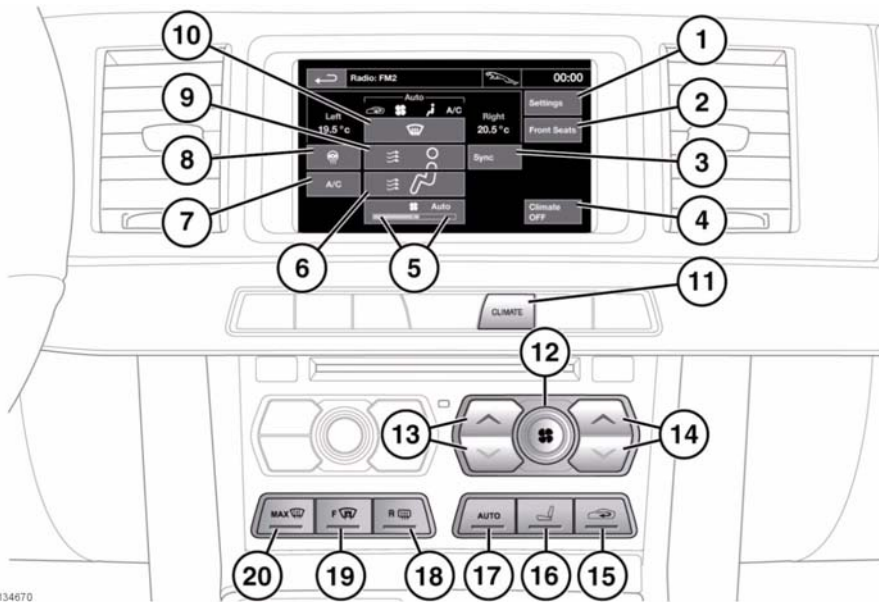

E134670

To access the Climate menu on the touch screen, select **Climate** from the home menu.

1. Touch to change the personal climate zone settings, to set the vent rotation mode and the automatic air recirculation sensor control settings.
2. Touch to access seat heating/ climate seat menu.
3. Touch to synchronize the passenger's climate zone to the driver's settings.
4. Touch to turn climate control off.
5. Indicates blower speed.
6. Touch to select air distribution to feet.
7. Air conditioning on/off. When the air conditioning is turned off, Economy mode is selected, which reduces the power consumed by the climate system.

Note: Prolonged use of Economy mode may cause the windows to mist.

8. Touch to select steering wheel heater on/off.
9. Touch to select air distribution to face.
10. Touch to select air distribution to the windscreen.
11. Press to short cut to touch screen climate menu.

Note: Not fitted on vehicles with the Navigation system.

12. Blower speed: Rotate to adjust blower speed.

Blower speed is automatically set in Auto mode. Adjusting the blower speed will cancel Auto mode.

Press centre button to switch climate system on/off.

Heating and ventilation

13. Left-hand temperature control: Press to adjust temperature for the left side of the vehicle. The temperature is displayed on the touch screen (**HI** or **LO** is displayed when the maximum or minimum setting is selected).

Note: *The maximum possible temperature differential between left and right hand temperature settings is 3°C (5.4°F).*

14. Right-hand temperature control: Press to adjust temperature for the right side of the vehicle. The temperature is displayed on the touch screen (**HI** or **LO** is displayed when the maximum or minimum setting is selected).
15. Press briefly to select timed recirculation. Press and hold to select continuous recirculation. Press again to switch off. See **64, RECIRCULATION**.
16. Press to access seat heating/ climate seat menu.
17. AUTO control: Press to switch automatic operation on.
18. Press to turn the heated rear screen on/off. See **64, HEATED SCREENS**.
19. Press to turn the heated front screen on/off. See **64, HEATED SCREENS**.
20. Defrost: Press to remove frost or heavy misting from the windscreen. This setting activates the blowers, air-conditioning, front and rear screen heaters and prohibits recirculation, to achieve a rapid defrost.

In addition to the selectable controls, the climate menu displays symbols that indicate the status of heating and ventilation functions.

Note: *If the climate control system is switched off, pressing an AUTO button or the Defrost button, will switch the climate system on.*

HEATED SCREENS

With the engine running, the front (**F**) and rear (**R**) screen heaters, may be switched on and off in any mode, including with the climate control system off.

The front and rear screen heaters switch off automatically after a timed period depending on the ambient temperature. In cold ambient conditions, below 5°C (41°F), the screen heaters will switch on automatically when the engine is started, unless the engine or vehicle interior is already warm.

RECIRCULATION

- Press briefly to activate timed recirculation. The button indicator illuminates when recirculation is on.
- Press and hold the button to activate continuous recirculation. the button indicator will flash and then illuminate constantly.
- To cancel recirculation, press the button briefly.

When selected, the air is recirculated inside the vehicle. This helps to maintain a high or low temperature, and is useful for preventing fumes from entering the vehicle.

Timed recirculation: Recirculation will switch off automatically after a set time (dependent on the ambient temperature).

Latched recirculation: Recirculation will remain on until the button is pressed again.

Note: *Prolonged use at low temperatures may cause the windows to mist.*

Recirculation may also be selected in AUTO mode, if the climate control system detects high levels of pollution in the atmosphere outside the vehicle (if an air quality sensor is fitted). Manual operation of the recirculation control will override the automatic setting.

AIR QUALITY SENSOR

If the air quality sensor detects pollution, air recirculation is selected automatically to reduce pollutants entering the vehicle.

The sensitivity of the sensor can be adjusted using the touch screen:

1. Select **Settings** from the Climate menu.
2. Touch the +/- buttons on the screen to increase/decrease sensitivity.

To switch the function off, decrease sensitivity to the minimum setting.



This icon appears at the top of the touch screen when the air quality sensor is switched on.

EXTERNAL TEMPERATURE

The external temperature is displayed in the Home menu of the touch screen and in the instrument panel.

When the external temperature is low enough that ice may be present on the road, an amber snowflake warning lamp will illuminate in the instrument panel.

AUTOMATIC CLIMATE CONTROL

AUTO mode should be used as the normal operating mode. The air conditioning, heating and ventilation controls automatically provide an optimum environment at the selected temperature.

Note: Screen heating and timed air recirculation may be selected in AUTO mode. Any other manual adjustment cancels AUTO operation.

Note: Water expelled by the air conditioning may collect underneath the vehicle when parked. This is not cause for concern.

TEMPERATURE CONTROLS

The driver and front seat passenger zone temperatures can be independently adjusted.

The temperature for each zone is displayed on the relevant side of the touch screen.

Note: The maximum possible temperature differential between the driver and passenger settings is 3°C (5.4°F).

HEATED SEATS

Note: The seat heaters will only operate when the engine is running.

The heated seats are controlled from the Home or Climate menu on the touch screen.

- Touch the appropriate seat icon to switch on the seat heater at maximum temperature (3 red bars).
- Touch the icon a second and third time to reduce the temperature (2 and 1 red bars).
- Touch the icon a fourth time to switch the seat heater off.

Heating and ventilation

CLIMATE SEATS

Note: *The climate seats will only operate when the engine is running.*

Seat ventilation is controlled from the Home or Climate menu on the touch screen.

Heated ventilation:

- Touch the red arrow above the appropriate seat icon to switch heated ventilation on at maximum (3 red bars).
- Touch the blue arrow below the seat icon once or twice to reduce the ventilation setting (2 and 1 red bars).
- Touch the blue arrow a third time to switch off seat ventilation.

Cooled ventilation:

- Touch the blue arrow below the appropriate seat icon to switch cooled ventilation on at maximum (3 blue bars).
- Touch the red arrow above the seat icon once or twice to reduce the ventilation setting (2 and 1 blue bars).
- Touch the red arrow a third time to switch off seat ventilation.

To select backrest ventilation only:

- Select **Settings** from the Climate menu.
- Select the appropriate icon for full seat or backrest only ventilation.

OPENING AND CLOSING THE LUGGAGE COMPARTMENT

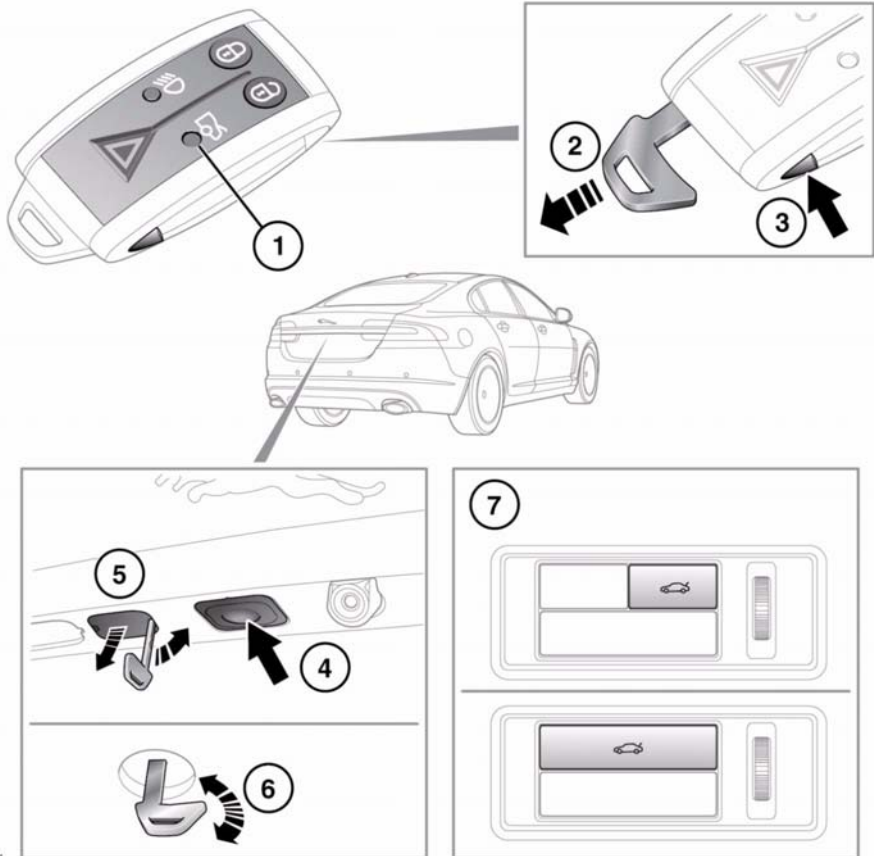

E135694

- ⚠ If the luggage compartment is opened after the driver and passenger doors are locked, ensure that the Jaguar Smart Key remains outside the vehicle when it is closed again.
- ⚠ If the Smart Key is inadvertently left inside the luggage compartment and the vehicle is locked and alarmed, a warning sounds and the compartment will re-open after 3 seconds.
- ⚠ The Smart Key may not be detected if it is placed within a metal container or if it is shielded by a device with a back-lit LCD screen, such as a smart phone, laptop (including laptop bag), games console etc.

Luggage compartment

- !** Do not repeatedly attempt to close the luggage compartment after it automatically re-opens, or the latch may overheat. If the cause of the automatic re-opening cannot be determined: Unlock all the doors and the luggage compartment with the Smart Key; make sure that all doors, the bonnet and the luggage compartment are closed properly; lock the vehicle again with the Smart Key.

The luggage compartment can be opened using the appropriate button (1) on the Smart Key, or via keyless entry (see **6, KEYLESS ENTRY**). Provided the vehicle is not locked, the luggage compartment can also be opened using either the interior release button (7) or the exterior release button (4).

The emergency key blade in the Smart Key can also be used to open the luggage compartment, as follows:

1. Press and hold the release button (3) on the Smart Key, then remove the emergency key blade (2).
2. Use the emergency key blade to remove the cap (5) from the trim panel above the license plate.
3. Insert the emergency key blade into the lock (6) and turn clockwise to open the luggage compartment.

If the security system is armed, the alarm will sound when the luggage compartment is opened. To deactivate the alarm, press the vehicle unlock button on the Smart Key or press the engine START/STOP button with the Smart Key inside the vehicle.

SOFT-CLOSE LID

- !** Care should be taken when manually latching the boot lid as the soft-close feature will automatically close the latch and possible injury may occur.

To activate the soft-close feature, lower the luggage compartment lid onto the latch. The lid will then automatically move to the fully closed and latched position.

LUGGAGE ANCHOR POINTS

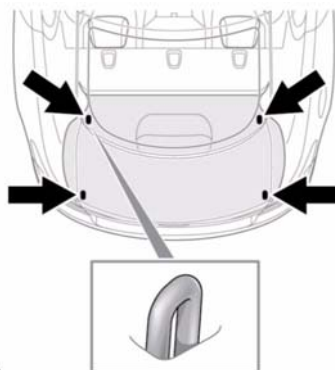

E134330

- !** All items carried in the vehicle should be properly secured.

Four securing points are provided in the luggage area to assist in safely securing items.

Note: A range of approved luggage retention accessories are available from your Dealer/ Authorised Repairer.

TOWING A TRAILER

(V6 petrol and diesel vehicles only)



Never exceed the maximum weights for the vehicle or the trailer. Damage to the vehicle could occur and vehicle stability and braking could be adversely affected. This could lead to loss of control and increased braking distance, resulting in a rollover or crash.



To preserve handling and stability, only fit Jaguar approved towing accessories.



Never use towing eyes or lashing points to tow a trailer. They have not been designed for this purpose and doing so may cause them to fail, resulting in injury or death.



When towing, do not exceed 100 km/h (60 mph). If using a temporary spare wheel, do not exceed 80 km/h (50 mph).

Note: *It is the driver's responsibility to ensure that the towing vehicle, and the trailer, are being used correctly and in accordance with manufacturer's recommendations and any applicable legislation.*

Information on towing, towing weight capacities and regulations is available from your Dealer and from the main motoring and caravanning organisations.

The following are important points of safety, stability and comfort. Seek further advice if necessary.

- Maximum braked towing weight is permissible, provided that long periods of uphill driving on gradients over 8% are not undertaken.
- At altitudes above 1000 metres (3250 feet), the stipulated maximum permitted Gross Train Weight must be reduced by 10% for every 1000 metres (3250 feet) in altitude, because the thinner atmosphere can reduce engine performance.

Diesel engines: When ambient temperature exceeds 40°C (104°F), the engine coolant temperature may increase above normal operating level. If this occurs, the engine management system will initiate a series of actions to restore normal operating conditions, which may include:

- A message centre message.
- Engine performance reduction.
- Air conditioning system cycling. The air conditioning temperature output will fluctuate between hot and cold, in order to dissipate engine heat. If engine overheat persists, the air conditioning will move to continuous heat output.

It is advisable to bring the vehicle and trailer to a convenient stop and allow the engine to idle until normal temperature is restored. Do not turn off the engine.

TRAILER ELECTRICAL CONNECTION



Only connect approved electrical circuits, which are in good condition, to the trailer socket. Connecting incorrect or faulty circuits, may seriously damage the vehicle's electrical circuits.

The vehicle's electrical system has been designed to support all towing requirements and comply with legal requirements for the specific territory in which the vehicle is first sold.

Note: *The rear parking sensors automatically disable when the trailer electrical connection is made using Jaguar approved towing equipment.*

Towing

TOWING WEIGHTS

	Maximum permissible towing weights
Unbraked trailers	750 kg (1653 lb.)
Trailers with overrun brakes	1850 kg (4080 lb.)
Nose/Tongue weight	75 kg (165 lb.)



Do not exceed the Gross Vehicle Weight (GVW), maximum rear axle weight, maximum trailer weight or nose/tongue weight. Exceeding any of these limits could cause instability and loss of control. See 176, WEIGHTS.

Nose/tongue weight must be the greater of 50 kg (110 lb.) or 7% of the actual trailer weight, up to the maximum tow hitch load.

Nose/tongue weight can be measured using a proprietary brand of nose weight indicator.

If it is necessary to increase the nose/tongue weight up to the maximum allowed, the vehicle load should be reduced accordingly. This ensures that the Gross Vehicle Weight (GVW) and maximum rear axle load are not exceeded.

Note: When towing the maximum permissible, Gross Vehicle Weight can be increased by a maximum of 100 kg (220 lb.), provided that the road speed is limited to 100 km/h (60 mph).

Note: When calculating rear axle loading, remember that the trailer nose/tongue weight, the load in the vehicle's luggage compartment and the weight of rear seat passengers must all be added together.

Towing weights - Australia only: The nose/tongue weight must be a minimum of 75% of gross caravan/trailer weight, up to a maximum of 350 kg (722 lb.).

ESSENTIAL TOWING CHECKS

- The trailer should be parallel to the ground when loaded and connected to the vehicle.
- When calculating the laden weight of the trailer, remember to include the weight of the trailer, plus the weight of the load.
- If the load can be divided between the vehicle and the trailer, loading more weight into the vehicle will generally improve the stability.
- Ensure that all applicable regulations and legislation are complied with when loading and towing a trailer.
- Increase rear tyre pressures of the towing vehicle to those for maximum loading conditions.
- Ensure trailer tyre pressures are set to trailer manufacturer's recommendations.
- If the vehicle is loaded to maximum Gross Vehicle Weight (GVW), the nose weight is limited.
- Ensure that a suitable breakaway cable or secondary coupling is used. Refer to the trailer manufacturer's instructions for guidance.



Do not loop the breakaway cable over the tow ball, as it may slide off.

- Ensure that the tow ball is secure.
- Check the operation of all trailer weights.

TOW BAR DIMENSIONS AND MOUNTING POINTS

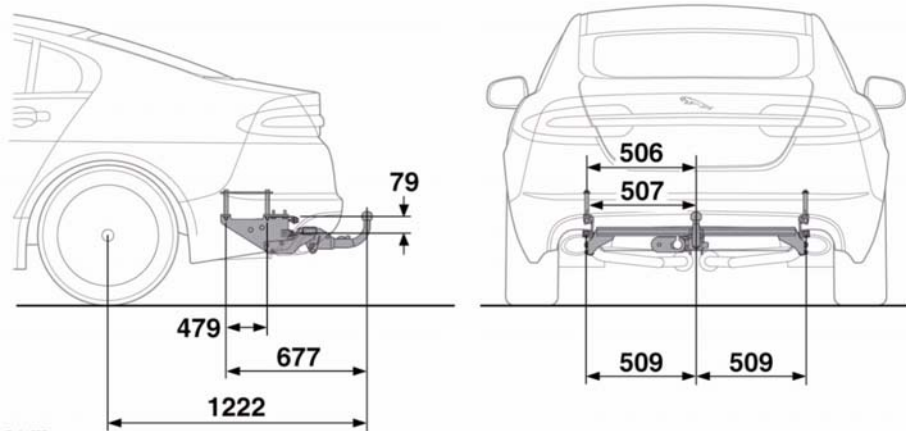

E134577

Note: Dimensions given are in millimetres.

Storage compartments

STORAGE COMPARTMENTS

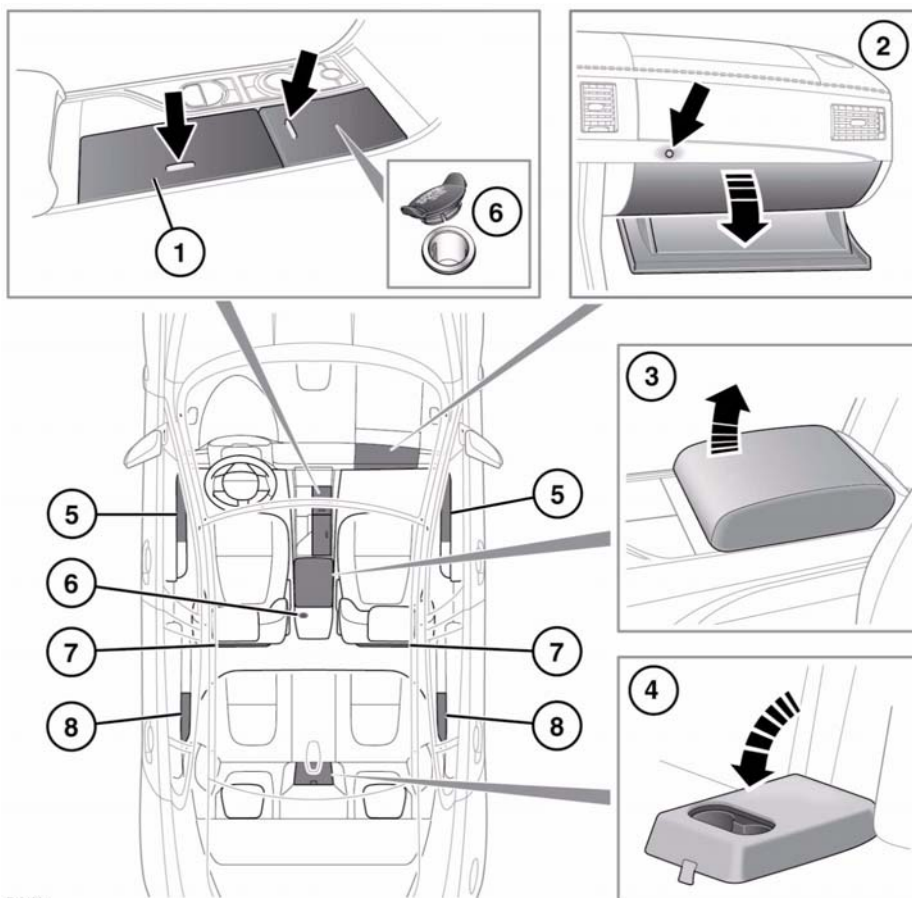

E134331

1. Cup holder. Press button to open.

To remove the cup holder insert for cleaning, lift the front edge rearwards and then upwards, to disengage the retaining clips.

When refitting the insert, push it fully into the compartment and run your thumb down the inside surface at the front and rear, to re-engage the clips. If the lid of the cup holder does not close correctly, the

insert has not been properly refitted.

⚠ Do not drink, or use the drinks holders when driving.

2. Glove box: Open using the glove box release (arrowed).

Note: When Valet mode is selected the glove box release is disabled.

3. Cubby box.

4. Rear cup holders.

5. Front door stowage.
6. Auxiliary power sockets.
 - ⓘ Only use approved accessories and always run the engine when using accessories for a prolonged period.
7. Map pockets.
8. Rear door stowage.

Starting the engine

STARTING A PETROL ENGINE

- ❗ The Smart Key may not be detected if it is placed within a metal container or if it is shielded by a device with a back-lit LCD screen, such as a smart phone, laptop (including laptop bag), games console etc. Keep the Smart Key clear of such devices when attempting Keyless entry or Keyless starting.

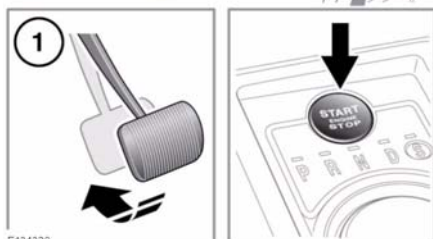
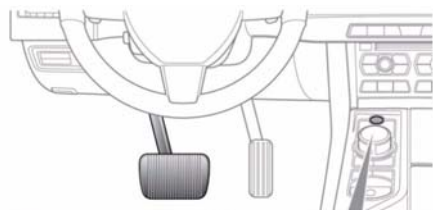

With the brake pedal applied (1) and with a valid Jaguar Smart Key in the vehicle, press and release the START/STOP button. The engine will start, the JaguarDrive selector will elevate out of the centre console and a drive gear can be selected.

Note: If, during the start procedure, the brake pedal is released, a gear change is made or if a fault occurs, **Smart Start cancelled** is displayed in the message centre and the start procedure is cancelled.

STARTING A DIESEL ENGINE

- ❗ The Smart Key may not be detected if it is placed within a metal container or if it is shielded by a device with a back-lit LCD screen, such as a smart phone, laptop (including laptop bag), games console etc. Keep the Smart Key clear of such devices when attempting Keyless entry or Keyless starting.

With the brake pedal applied and with a valid Jaguar Smart Key in the vehicle, press and release the START/STOP button. In ambient conditions, within 3 seconds, the engine will start to crank. The JaguarDrive selector will elevate out of the centre console.

In very cold conditions, expect engine cranking times to increase.

Note: If, during the start procedure, the brake pedal is released, a gear change is made or if a fault occurs, **Smart Start cancelled** is displayed in the message centre and the start procedure is cancelled.

SWITCHING ON THE IGNITION

To turn on the ignition without starting the engine, make sure the brake pedal is not applied and that there is a valid Smart Key in the vehicle, then press and release the START/STOP button.

Note: If the brake pedal is pressed when the START/STOP button is pressed, the engine will start.

STEERING COLUMN LOCK

The steering column has an electronic lock, which locks and unlocks in conjunction with the vehicle Locking/Alarm system. The steering column lock also locks when the ignition is switched off, after a time delay. If the steering column lock malfunctions, **Steering Column Locked** is displayed in the message centre. If this occurs:

1. Lock and then unlock the vehicle using the Smart Key.
2. Try again to unlock the steering column lock, by turning the steering wheel gently to the left and right.
3. If the malfunction persists, seek qualified assistance immediately.

SWITCHING OFF THE ENGINE

With the gear selector in position **P**, press the engine START/STOP button. The engine will stop and the ignition system will return to convenience mode. The audio, telephone and touch screen systems will revert to stand-by mode and the JaguarDrive selector will retract into the centre console.

Starting the engine

IF THE ENGINE FAILS TO START

If the brake pedal has been pumped prior to an attempt to start the engine, it may require greater pressure on the pedal in order for the engine to start.

If the Jaguar Smart Key is placed in the door pocket, it may be outside the range of the sensors when the door is open.

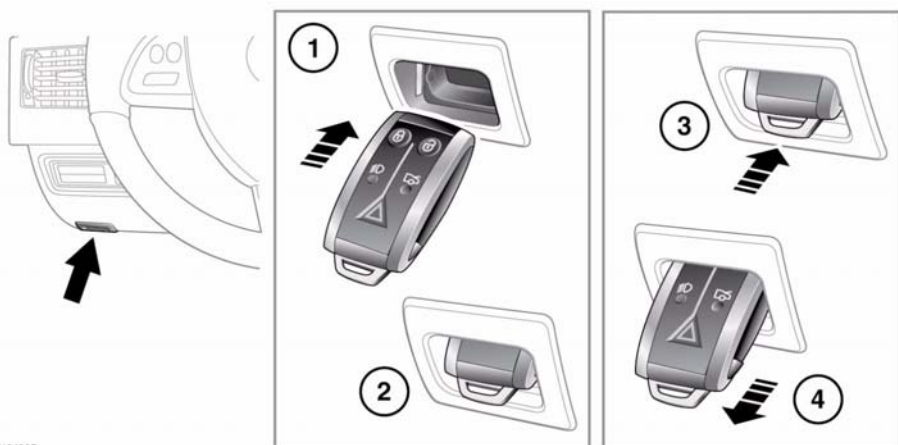

E134395

If the Smart Key fails to operate, **Smart Key Not Found- Refer to Handbook** is displayed in the message centre. To start the engine it will be necessary to dock the Smart Key, as follows:

1. Insert the Smart Key fully into the starter control unit, as shown.

Note: When docking the Smart Key, it is recommended that the emergency key blade is left in place. The end of the blade can then be used as a handle, to pull the Smart Key from the control unit when undocking.

2. Ensure the Smart Key is securely docked, then press and release the START/STOP button with the brake pedal applied to start the engine.

3. To undock the smart key, ensure that the gear selector is in the **P** position and the ignition is switched off, then press and release the Smart Key. The Smart Key will eject from the starter control unit.

! Ensure that the ignition is switched off before undocking the Smart Key, otherwise damage to the Smart Key may occur.

4. Remove the Smart Key.

If the engine still fails to start, seek qualified assistance.

PETROL ENGINES

If the engine persistently fails to start, press the START/STOP button (without applying the brake pedal) to return the ignition to convenience mode. Slowly depress the accelerator pedal fully, hold it in this position and press the START/STOP button with the brake pedal applied, the engine will start to crank. Release the accelerator pedal when the engine starts.

If the engine still fails to start, consult your Dealer/Authorised Repairer.

DIESEL ENGINES

If the engine persistently fails to start, press and hold the START/STOP button (with the brake pedal applied). Keep the START/STOP button and the brake pedal pressed until the engine starts, then release.

If the engine still fails to start, consult your Dealer/Authorised Repairer.

SWITCHING OFF THE ENGINE WHILE MOVING



It is not advisable to switch off the engine whilst the vehicle is moving. However, should such a situation arise, then the following procedure applies.

- Press and hold the engine START/STOP button for 2 seconds, or;
- Press the engine START/STOP button twice within 2 seconds.

In either case, the warning **Engine stop button pressed** will be displayed in the message centre.

ROLLING RE-START

If the engine is switched off whilst the vehicle is moving, a rolling re-start can be initiated by selecting neutral and pressing the engine START/STOP button.

ECO STOP/START

The Stop/Start system is designed to improve fuel efficiency and is automatically activated when the ignition is turned on. If the vehicle is stopped (e.g. at traffic lights or in traffic), the engine will turn off (unless it is required to support other vehicle systems). When the brake is released and a drive gear is selected, the engine will restart automatically.



The warning lamp in the instrument panel illuminates when the engine has been switched off by the Stop/Start system.

To activate an automatic engine stop:

- Stop the vehicle from a speed greater than 4 km/h (2.5 mph) and apply sufficient brake pressure to ensure the vehicle is stationary.
- Alternatively, whilst stationary, select **P** (Park) or **N** (Neutral).

To activate an automatic engine restart release the brake pedal with **D** (Drive) or **S** (Sport) selected.

Starting the engine

The engine will also restart if one of the following occurs:

- The accelerator pedal is pressed.
- A shift paddle is used to select a gear.
- **R** (Reverse) is selected.
- Climate control system demand increases.
- The vehicle's speed exceeds approximately 1 km/h (0.5 mph).
- Battery charge becomes low.
- Brake vacuum has been reduced (e.g. using the brake pedal repeatedly with the engine off).
- Eco Stop/Start is deactivated.

The following conditions will prevent an automatic engine stop:

- A shift paddle has been used to select a gear.
- The external temperature is less than approximately 0 °C (32 °F).
- The external temperature is more than approximately 40 °C (104 °F).
- The engine has not reached operating temperature.
- The driver's door is opened.
- The driver's seat belt is not fastened.
- The climate control system demand requires the engine to be running (for example, in Defrost mode).
- The battery charge is low.
- The bonnet is opened.
- Eco Stop/Start is deactivated.

DEACTIVATING ECO STOP/START

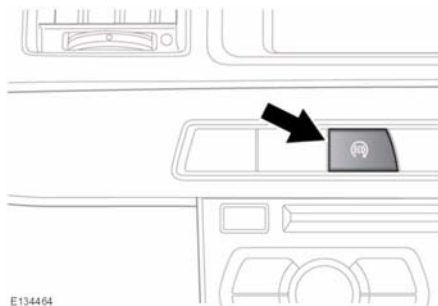

To switch the system off, press the Eco switch.

Note: The engine will restart automatically if the switch is pressed whilst an automatic engine stop is in progress.



To confirm that the system is off, the Eco system off warning symbol illuminates and the message Eco Stop/Start Off is momentarily displayed in the message centre.

The Eco system off warning symbol also illuminates if there is a system fault. If the Eco switch is pressed while there is a fault, the message **ECO Start Stop Fault** is displayed.

ECO STOP/START

The Stop/Start system is designed to improve fuel efficiency and is automatically activated when the ignition is turned on. If the vehicle is stopped (e.g. at traffic lights or in traffic), the engine will turn off (unless it is required to support other vehicle systems). When the brake is released and a drive gear is selected, the engine will restart automatically.



The warning lamp in the instrument panel illuminates when the engine has been switched off by the Stop/Start system.

To activate an automatic engine stop:

- Stop the vehicle from a speed greater than 4 km/h (2.5 mph) and apply sufficient brake pressure to ensure the vehicle is stationary.
- Alternatively, whilst stationary, select **P** (Park) or **N** (Neutral).

To activate an automatic engine restart release the brake pedal with **D** (Drive) or **S** (Sport) selected.

The engine will also restart if one of the following occurs:

- The accelerator pedal is pressed.
- A shift paddle is used to select a gear.
- **R** (Reverse) is selected.
- Climate control system demand increases.
- The vehicle's speed exceeds approximately 1 km/h (0.5 mph).
- Battery charge becomes low.
- Brake vacuum has been reduced (e.g. using the brake pedal repeatedly with the engine off).
- Stop/Start is deactivated.

The following conditions will prevent an automatic engine stop:

- A shift paddle has been used to select a gear.
- The external temperature is less than approximately 0 °C (32 °F).
- The external temperature is more than approximately 40 °C (104 °F).
- The engine has not reached operating temperature.
- The driver's door is opened.
- The driver's seat belt is not fastened.
- The climate control system demand requires the engine to be running (for example, in Defrost mode).
- The battery charge is low.
- The bonnet is opened.
- Stop/Start is deactivated.

Intelligent stop/start

DEACTIVATING ECO STOP/START

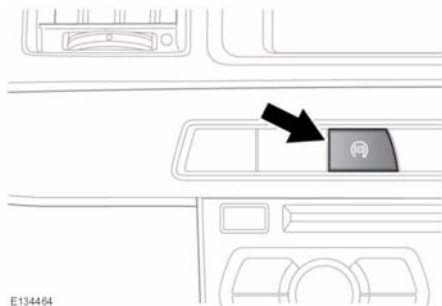

E134464

To switch the system off, press the Eco switch.

Note: *The engine will restart automatically if the switch is pressed whilst an automatic engine stop is in progress.*



To confirm that the system is off, the Eco system off warning symbol illuminates and the message Eco Stop/Start Off is momentarily displayed in the message centre.

The Eco system off warning symbol also illuminates if there is a system fault. If the Eco switch is pressed while there is a fault, the message **ECO Start Stop Fault** is displayed.

AUTOMATIC TRANSMISSION

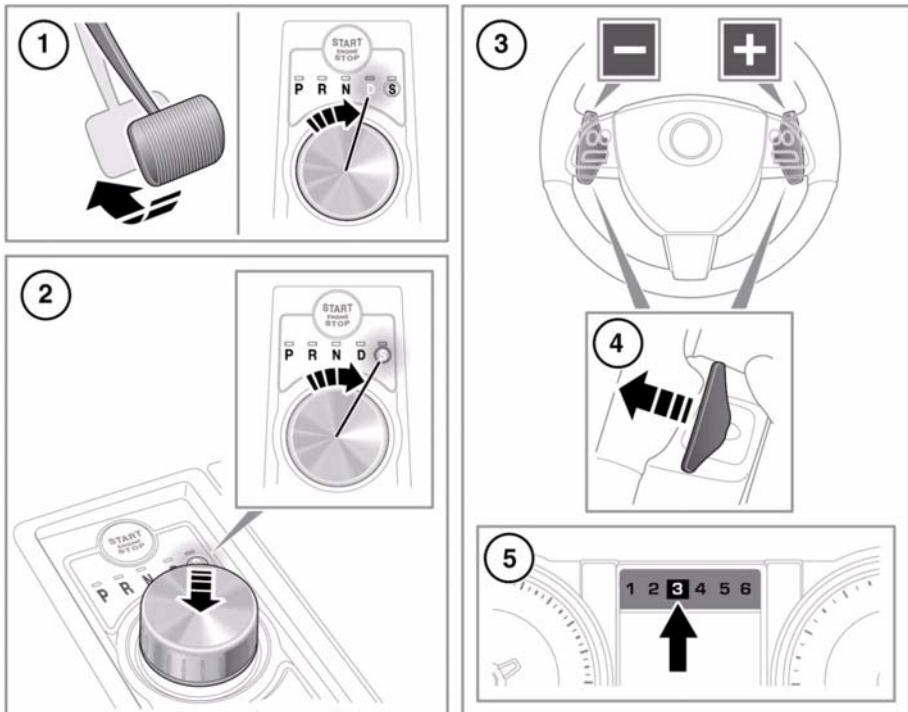

E134359

1. To select drive or reverse gear, press the brake pedal and rotate the drive selector.
2. To select sport mode, from **D** press the drive selector down and rotate to **S**.
3. Gear shift paddles (left paddle for downshifts, right paddle for upshifts).
4. Pull briefly to change gear.
To exit manual mode, either pull and hold the shift-up paddle for approximately one second (to return directly to automatic operation in **D** or **S**), or if in **S**, rotate the gear selector to the **D** position.
5. Selected gear display when using manual gear selection.

Note: Display shows eight gears on vehicles with I4 diesel engine.

- ⚠ Never select the Park (**P**) position whilst the vehicle is in motion.
- ⚠ Never select the Reverse (**R**) position whilst the vehicle is in forward motion.
- ⚠ Never select a forward gear whilst the vehicle is moving backwards.
- ⚠ Do not rev the engine or allow it to run above normal idle speed while selecting **D** or **R**, or while the vehicle is stationary with any gear selected.



Do not allow the vehicle to remain stationary with a drive gear selected and the engine running. Always select **P** or **N** if the engine is to idle for a prolonged period.

ROTARY GEAR SELECTOR

The JaguarDrive selector elevates out of the centre console when the engine is started, in readiness for gear selection

P should be selected before switching off the engine. However, it is possible to switch the engine off with **R**, **D** or **S** selected - the selector will automatically select **P**, while retracting into the centre console.

Note: *If the engine is switched off with **N** selected, the system will wait for 10 minutes before selecting **P**. This procedure is to allow the vehicle to be conveyed through a car wash only and should not be used for vehicle recovery purposes.*

In the event of a vehicle breakdown, the transmission will automatically select **P**. This prevents the vehicle from being towed on all four wheels. Therefore, vehicle recovery should only be undertaken by suitably qualified personnel.

IF THE SELECTOR FAILS TO ELEVATE

If the JaguarDrive selector is obstructed remove the obstruction and then start the engine. The selector should elevate as normal.

If the selector still fails to elevate, even if there is no obstruction, a fault in the system is indicated. The selector can still be used in the lowered position, but be aware that it will not automatically select **P** when the engine is switched off. **P** should be selected manually. The fault should be rectified by a Dealer/ Authorised Repairer at the earliest opportunity.

MANUAL GEAR SELECTION

When the gear selector is in the **D** position, manual mode may be directly accessed by the single action of operating the steering wheel mounted shift paddles.

If continued use of manual mode is required, the gear selector may be subsequently moved to the **S** position to enter permanent manual mode.

If the gear selector remains in the **D** position, temporary manual mode will be held whilst the driver is accelerating, decelerating, cornering or continuing to request shifts via the paddles.

LIMP-HOME MODE

Note: *The driver should be aware that the vehicle's performance will be reduced and must take this into account when driving. Also the use of the **Jaguar Sequential Shift** paddles will be disabled. In this event, seek qualified assistance as soon as possible.*

In the event of an electrical or mechanical failure, transmission operation will be limited. **P**, **R**, **N**, **D** and **S** may still be used to enable the vehicle to be driven to a safe area.

Some faults will cause the selector to be locked in position until the ignition is switched off. If the selected range flashes, it signifies that the driver request cannot be engaged. Re-select **N** and repeat the attempt.

If the transmission is still unable to select the requested gear, contact your Dealer/ Authorised Repairer.

WINTER MODE



Press to operate. Designed for use in slippery conditions, when active, Winter mode selects 2nd gear for driving away on level ground (no incline), softens the responsiveness of the engine and modifies the gear change strategy. This helps ensure that optimum traction is maintained.

Winter mode optimises stability of the vehicle to suit slippery conditions, when grip is reduced. This helps the vehicle to perform in a more gentle and controlled manner, to avoid skidding, allowing more confident progress under adverse conditions.

Note: *Winter mode cannot be active at the same time as Dynamic mode. Winter mode will remain selected indefinitely, even after the ignition is switched off. Winter mode must be deselected if no longer required.*

DYNAMIC MODE



Press to operate. Dynamic mode co-ordinates the vehicle's control systems to deliver a high performance driving experience. This setting enhances key vehicle systems so that the vehicle's full potential can be exploited. The vehicle's responses are aimed at involving the driver more in focused and purposeful driving.

Note: *When the transmission is set to permanent manual mode and Dynamic mode is selected, transmission upshifts are fully controlled by the driver. The transmission will not change up automatically, even when the rev limit is reached (the gear position indicator in the message centre will glow amber, to indicate that the next gear should be selected).*

Note: *Dynamic mode cannot be active at the same time as Winter mode. Dynamic mode will remain selected for approximately six hours after the ignition is switched off, after which point it will need to be reselected if required.*

TRACDSC



Vehicle safety may be reduced by inappropriate use of Trac DSC. Trac DSC should only be used in suitable conditions.

Trac DSC is an alternative setting of DSC, with reduced system interventions. With Trac DSC engaged, traction may be increased, although stability may be reduced compared to normal DSC. Trac DSC is intended for use only on dry tarmac, by suitably experienced drivers. Trac DSC should not be selected for other surfaces or by drivers with insufficient skill and training to operate the vehicle safely with Trac DSC function engaged.

Stability control

SWITCHING BETWEEN DSC AND TRACDSC



Press and hold the DSC switch for less than 10 seconds. The message centre will temporarily display either Trac DSC or DSC ON.

- The warning lamp in the instrument panel will illuminate while Trac DSC is selected.
- The DSC warning lamp will flash when DSC or Trac DSC is active (cruise control will automatically disengage if this occurs).

SWITCHING DSC OFF

- Press and hold the DSC switch for more than 10 seconds.
- The message centre will display **DSC OFF** and a short warning chime will sound.
- The DSC OFF warning lamp in the instrument panel will illuminate.

SWITCHING DSC ON

- Press and release the DSC switch.
- The DSC system will switch on, the message centre will temporarily display **DSC ON**.
- The DSC OFF warning lamp in the instrument panel will be extinguished.

Note: Switching the engine off and then on again, will always revert DSC status to DSC ON, regardless of which mode is selected.

STABILITY CONTROL WARNING LAMPS



Flashes when DSC is active.

If there is a fault, this warning lamp will illuminate in the instrument panel and the message centre will display **DSC NOT AVAILABLE**.

The vehicle can still be driven, but the DSC system will not activate under wheel spin or slide conditions. You should seek qualified assistance as soon as possible.



If DSC is switched off, this warning lamp will illuminate in the instrument panel, the message DSC OFF is displayed and a warning chime will sound.

ADAPTIVE DYNAMICS

Jaguar adaptive dynamics continuously monitors the road and driver inputs and optimises the vehicle suspension settings for ride comfort and control.

The adaptive dynamics system is linked to Dynamic mode, modifying the suspension settings for a more sporting character.

If **ADAPTIVE DYNAMICS FAULT** is displayed in the message centre, the vehicle can still be driven, but seek qualified assistance to have the fault rectified.

ACTIVE DIFFERENTIAL CONTROL (Supercharged vehicles only)

The Active differential control (E-diff) improves traction on uneven road surfaces and can also improve stability in oversteer situations.

If the warning message **EDIFF SYSTEM FAULT** is displayed and DSC is off, then Trac DSC will be automatically selected. The vehicle can still be driven and DSC modes can be selected, but seek qualified assistance as soon as possible.

If the warning message **EDIFF NOT AVAILABLE** is displayed, the system has temporarily shut down to prevent overheating. The vehicle can still be driven and the E-diff will be operational again when the system has cooled sufficiently.





Stability control

JAGUAR DRIVE CONTROL SCENARIOS

The table below gives examples of the drive control settings suggested for different driving scenarios.

Scenario	Suggested driver selection			
	Tyre fitment	Jaguar Drive Control	Dynamic Stability Control (DSC)	Transmission
Wet grass	Standard	Winter mode	Default (On)	Drive (D)
Very wet tarmac				
Slippery boat launch ramp				
Hill descents while towing on slippery surfaces				Sport (S) + Manual
Ice/light snow	Standard or All Season tyres	No driver selection required. Special modes off	Default (On)	Drive (D)
Snow ploughed hard-topped roads (including black ice)	All Season tyres			
Packed snow roads	Winter tyres			
Deep fresh snow	Snow chains			Sport (S)
Normal driving conditions (e.g. dry tarmac, town driving, motorway cruising etc.)	Standard	No driver selection required. Special modes off	Default (On)	Drive (D)
Overtaking on a dry road				Drive (D) or Sport (S)
Pulling out onto a busy road in dry conditions				
Favourite country lane (public road)	Standard	Dynamic mode	Trac DSC (where conditions permit)	Sport (S) or Sport (S) + Manual
Private track/race day	Standard			

IMPORTANT INFORMATION

-  Do not rest your foot on the brake pedal whilst the vehicle is in motion.
-  Never allow the vehicle to coast (freewheel) with the engine turned off. The engine must be running to provide full braking assistance. The brakes will still function with the engine off, but far more pressure will be required to operate them.
-  If the red brake warning lamp illuminates, safely bring the vehicle to a stop, as quickly as possible and seek qualified assistance.
-  Never place non-approved floor matting or any other obstructions under the brake pedal. This restricts pedal travel and braking efficiency.

Driving through heavy rain or water can have an adverse effect on braking efficiency. Under such circumstances, it is recommended that you lightly apply the brakes intermittently to dry the brakes.

BRAKE WARNING LAMPS



If the parking brake is released and this red warning lamp illuminates while driving and/or the message Brake Fluid Low is displayed in the message centre, check the brake fluid level at the earliest opportunity and top-up as required.



If this amber warning lamp illuminates while driving and/or ABS Fault is displayed in the message centre, drive with extra caution, avoid heavy braking where possible, and seek qualified assistance as soon as possible.

Note: This warning lamp will also illuminate if there is a fault with the parking brake. See 88, ELECTRIC PARKING BRAKE (EPB).

ELECTRONIC BRAKE FORCE DISTRIBUTION (EBD)

EBD balances the distribution of braking forces between the wheels on the front and rear axles, to maintain maximum braking under all vehicle loading conditions.

For example; Under light loads, EBD applies less braking effort to the rear wheels, to maintain stability. Conversely, it allows full braking effort to the rear wheels when the vehicle is heavily laden.

A fault with the EBD system is indicated by the red brake warning lamp and the message **EBD FAULT**. The braking system will still operate, but without EBD assistance. Seek qualified assistance to have the fault rectified.

EMERGENCY BRAKE ASSIST (EBA)

The EBA system measures the rate at which the brake pressure increases. If the system detects an emergency braking situation, EBA automatically initiates full braking effect. This can reduce stopping distances in critical situations.

A fault with the EBA system is indicated by the brake warning lamp illuminating and **Emergency Brake Assist Not Available** displaying in the message centre. The braking system will still function, but without EBA assistance. Seek qualified assistance to have the fault rectified.

EMERGENCY STOP SIGNAL (ESS)

ESS (Emergency Stop Signal) automatically activates the hazard warning lights during emergency braking to warn other road users and reduce the risk of a collision.

ELECTRIC PARKING BRAKE (EPB)

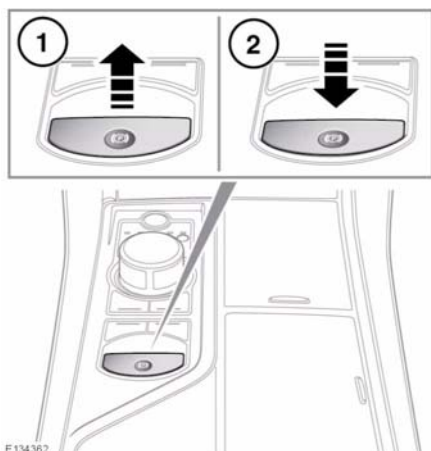

The switch which operates the parking brake is mounted on the centre console to the rear of the gear selector.

To engage the parking brake (1): Pull the parking brake switch upwards and release. The switch will return to the neutral position.

The red brake warning lamp on the instrument panel will illuminate.

The Drive Away Release feature allows the parking brake to release automatically as the vehicle is driven away.

The warning lamp will remain on briefly if the parking brake is applied when the ignition system is reverted to convenience mode.

If a fault in the system is detected, the amber brake warning lamp will illuminate and **PARK BRAKE FAULT** or **CANNOT APPLY PARK BRAKE** will be displayed in the message centre. Seek qualified assistance as soon as possible.

If the battery has been discharged or disconnected, **APPLY FOOT AND PARK BRAKE** will be displayed in the message centre when the ignition is next switched on. Depress the foot brake and pull the parking brake switch up to apply the parking brake. This is required to reset the parking brake system. The parking brake will now function correctly.

To disengage the parking brake (2): With the ignition system on or with the engine running, apply the foot brake and press the parking brake switch down.

If the parking brake is applied while the vehicle is stationary and **D** or **R** is selected, applying the throttle will automatically release the parking brake.

The parking brake is also automatically released when the gear selector is moved from the **P** position.

If the parking brake is inadvertently applied when the vehicle is moving at above 3 km/h (1.8 mph), **PARK BRAKE APPLIED** is displayed in the message centre, the warning indicator in the instrument panel will illuminate and a warning chime will sound.



If the parking brake is applied whilst the vehicle is moving, releasing the switch will disengage the parking brake. The parking brake cannot be applied when the vehicle is moving, if the accelerator pedal is pressed.

Note: *If the vehicle is in motion, the parking brake should only be used as an emergency brake.*



Always apply the parking brake when the vehicle is parked.

TYRE PRESSURE MONITORING SYSTEM (TPMS)

-  The TPM system provides a low pressure warning and does not re-inflate your tyres. Tyre pressures should be checked regularly using an accurate pressure gauge when cold.
-  The TPM system can NOT register damage to a tyre. Regularly check the condition of your tyres, especially if the vehicle is driven off-road.
-  When inflating tyres, care should be taken to avoid bending or damaging the TPM system valves. Always ensure correct alignment of the inflation head to the valve stem.

Note: Non-approved accessories may interfere with the system. If this occurs, **TYRE PRESSURE MONITORING SYSTEM FAULT** is displayed in the message centre.

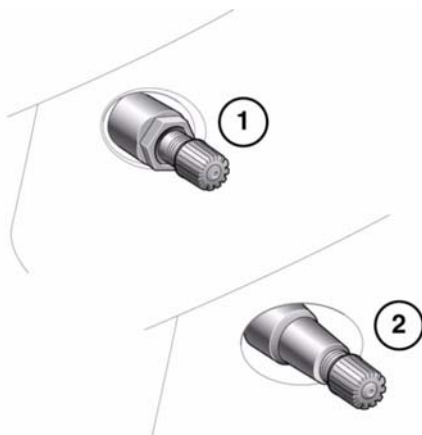

E132513

Wheels fitted with a TPM system can be visually identified by the external metal lock nut and valve (1). All Jaguar non-TPM system wheels have a rubber valve fitted (2).

TPMS OPERATION

The TPM system monitors pressure of the tyres via sensors located in each wheel and a receiver located within the vehicle. Communication between sensor and receiver is via Radio Frequency (RF) signals.



The tyre pressure warning comprises a yellow warning telltale within the instrument panel, and the associated messages within the message centre.

If the telltale light illuminates, you should stop and check your tyres as soon as possible and inflate them to the recommended pressure as stated on the tyre pressure placard. If low pressure warnings occur frequently, the cause must be determined and rectified.

When driving through variable climatic conditions the TPM system warnings may be intermittent.

Your vehicle will also indicate a TPM system malfunction by initially flashing and subsequent continuous illumination of the warning telltale. A text message will accompany the system malfunction and will display **TYRE PRESSURE MONITORING SYSTEM FAULT**. The TPM system fault sequence will be activated at every ignition cycle until the fault is rectified. When a malfunction occurs, the system may not be able to detect or signal low tyre pressure as intended.

TPM system malfunctions may occur for a variety of reasons which may include other radio frequency systems that could cause interference or the installation of incompatible replacement tyres on the vehicle.

Tyre pressure monitoring system

TEMPORARY USE SPARE WHEEL AND TYRE CHANGE

If the temporary use spare wheel is fitted the system will automatically recognise the change in wheel positions. Then after approximately ten minutes of driving above 25 km/h (18 mph), a message detailing which tyre is affected (e.g. **FRONT LEFT**) and **TYRE NOT MONITORED** will be displayed accompanied by illumination of the warning telltale and the corresponding block in the vehicle graphic.

The warning telltale will initially flash and will subsequently revert to continuous illumination. Extended use of the temporary use spare wheel will produce an additional text message **TYRE PRESSURE MONITORING SYSTEM FAULT**.

This TPM system display sequence will be activated at every ignition cycle until the temporary use spare wheel is replaced by a fully operational full size wheel and tyre assembly. Always replace the temporary use wheel before having TPM system faults investigated. The fault may well be rectified with the fitment of a fully operational full size running tyre in lieu of the temporary use spare wheel assembly.

TYRE PRESSURE MONITORING UNAVAILABLE

If all four running wheels and tyres are changed for a set that are not fitted with TPM system sensors (e.g. a set of winter wheels and tyres), the message **TYRE PRESSURE MONITORING UNAVAILABLE** is displayed. TPM system sensors must be fitted to the wheels and tyres for the system to be able to warn of low tyre pressures.

When sensors are fitted to the replacement wheel and tyre set, the vehicle needs to be driven until the TPM system recognizes the sensors before TPM will be available (**TYRE PRESSURE MONITORING AVAILABLE** is displayed).

TYRE CHANGING

Always have your tyres serviced or changed by a qualified technician.

Care must be taken to avoid contact between the bead of the tyre and the sensor during removal and refitting of the tyre, otherwise the sensor may become damaged and or inoperable.



Valve stem seal, washer, nut, valve core and cap should be replaced at every tyre change. Valve stem seal, washer and nut must be replaced if valve retention nut is loosened. Sensor units and nuts must be refitted using correct torque figures and associated profile. Damage to the vehicle may result if these precautions are not taken.

Sensors can be removed from the wheel by the unscrewing of the valve retention nut.

REPLACEMENT TPMS SENSOR

Should the sensor require replacing, it should be carried out by a Dealer/Authorised Repairer.

A replacement sensor must be fitted to a running wheel in order to be recognised by the system. The vehicle needs to be stationary for 15 minutes during the sensor fitment before the system is ready to detect the new sensor. The vehicle must be driven for a minimum of fifteen minutes after the sensor change, and then remain stationary for fifteen minutes to activate full TPM system operation.

If the TPM system warning for any wheel does not clear, even after ensuring correct inflation and driving for more than ten minutes above 25 km/h (18 mph), you should seek qualified assistance as soon as possible.

Parking aids

PARKING AID OPERATION

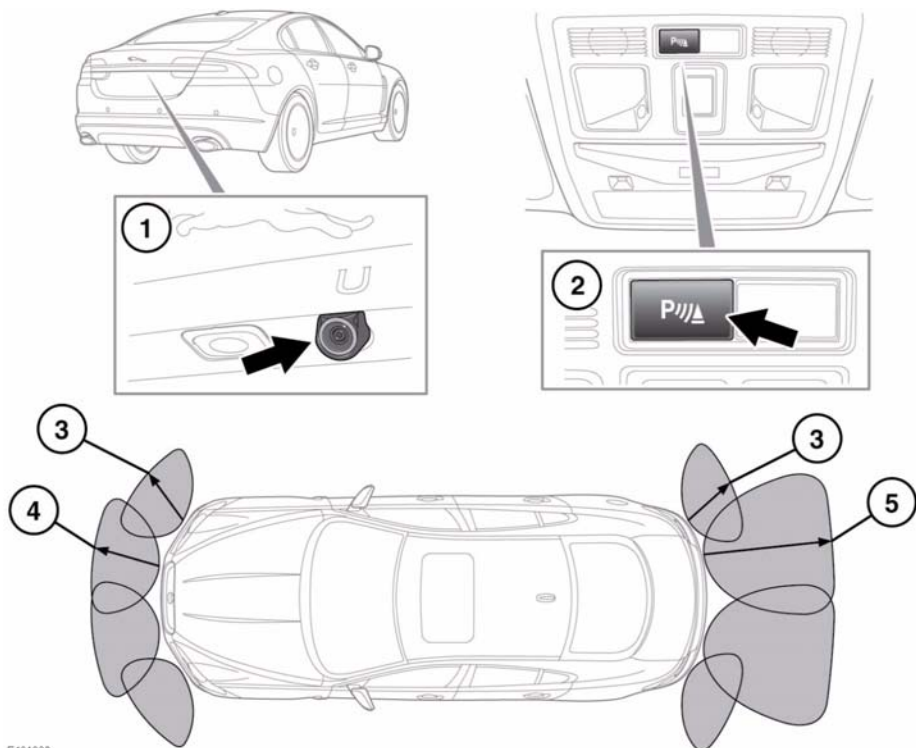

E134360

1. Rear view camera. See **93, REAR VIEW CAMERA**.
2. Parking aid switch: Press to turn the parking aid on and off.
3. Approximately 600 mm (24 inches).
4. Approximately 800 mm (31 inches).
5. Approximately 1800mm (71 inches).



It remains the driver's responsibility to detect obstacles and estimate the vehicle's distance from them. Some overhanging objects, barriers, small children, animals, thin obstructions or painted surfaces may not be detected by the system.



Systems using the same frequency band as the front parking sensors, may cause irregular tones to be emitted.

Note: The sensors are active when the gear selector is in neutral, and in drive after moving from reverse. Therefore, if an obstacle is detected an audible warning tone will sound.

REAR FITTED ACCESSORIES

Particular care must be taken when reversing with rear fitted accessories, as the rear parking aid will only indicate the distance from the bumper to the obstacle.

CLEANING THE SENSORS

For reliable operation, the sensors in the front and rear bumpers should be kept free from ice, frost and grime.

- ❗ Do not clean the sensors with abrasive or sharp objects or materials.
- ❗ When using a high pressure spray, only spray the sensors briefly, from a distance greater than 200 mm (8 inches).

PARKING AID SYSTEM FAULT

If the system has a fault when engaging reverse gear or turning on the ignition, then a single, 3 second tone will be heard and a pop-up warning will appear on the touch screen. If both front and rear parking aids are fitted, the warning indicator in the parking aid switch will flash for 3 seconds and then switch off.

If a fault is detected, the system is automatically disabled.

Note: The parking aid may emit spurious tones if it detects a frequency tone using the same band as the sensors (e.g. air brakes).

REAR VIEW CAMERA

⚠ **It remains the driver's responsibility to detect obstacles and estimate the vehicle's distance from them when reversing.**

When Reverse (R) is selected, the system uses a camera to provide a wide-angle colour rear view image on the touch screen.

The camera display has priority over the parking aid display. To view the parking aid display instead, or to cancel camera display at any time, touch the display.

The display also incorporates graphic overlays, indicating vehicle direction, width and proximity to surrounding objects.

The camera image will not be displayed;

- If Drive (D) is selected and the vehicle speed is greater than 16 km/h (10 mph).
- If Drive (D) is selected for longer than 2 seconds.

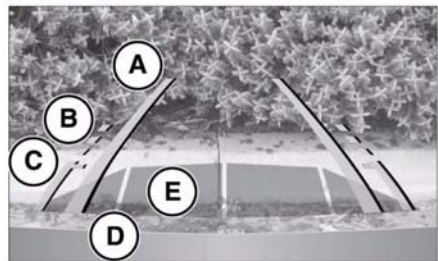
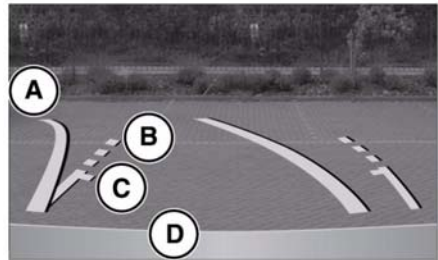

E132516

- A. Solid line: The projected wheel trajectory.
- B. Dotted line: The safe working width of the vehicle (including exterior mirrors).
- C. Boot access guideline: Do not reverse beyond this point if boot access is required.
- D. Bumper inclusion.
- E. Parking sensor activation: A coloured area appears, to indicate which rear sensor(s) has been activated.

Cruise control

USING CRUISE CONTROL

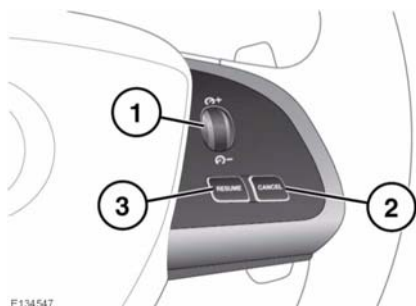



E134547

The cruise (speed) control system can be used by the driver to maintain a selected vehicle speed above 30 km/h (18 mph).

1. **SET (+/-)**: Roll upwards to engage cruise control. Roll up or down to increase or decrease the set cruising speed.
2. **CANCEL**: Press to disengage cruise control. The set speed memory will be retained.
3. **RESUME**: Resumes the cruise control set speed after it has been disengaged.

SETTING VEHICLE SPEED

 **Only use cruise control when conditions are favourable (e.g. straight, dry, open roads with light traffic).**

 **In certain conditions, such as a steep downhill gradient, the vehicle speed may exceed the set cruising speed. This is because engine braking is unable to maintain or reduce the vehicle speed. Driver intervention may be required.**

When you are travelling at the speed you require press the set button.

Cruise control will engage and maintain the set speed and you can remove your foot from the accelerator pedal.

Note: Cruise control will automatically disengage when the brake pedal is pressed or when the vehicle speed falls below 30 km/h (18 mph).

CHANGING THE CRUISE SPEED

There are two ways to change the set speed:

- Accelerate or decelerate to the desired speed then roll the **SET** control upwards.
- Increase or decrease the speed by rolling the **SET** control up or down until the desired speed is obtained.

Note: The set speed can be increased or decreased in steps of 2 km/h (1 mph), by rolling the **SET** control up or down briefly until the desired speed is obtained.

RESUMING THE SET SPEED

If the vehicle is accelerated above the set speed, then the set speed will be resumed when the accelerator pedal is released.

If the **CANCEL** button (2) or the brake pedal is pressed, the cruise control will disengage but the set speed memory will be retained. Press **RESUME** (3) and the vehicle will return to the set speed.

Note: Cruise control will not resume at speeds below 30 km/h (18 mph).

 **RESUME** should only be used if the driver is aware of the set speed and intends to return to it.

 It is not recommended to resume set speed when a low gear is selected as excessive engine speeds will occur.

AUTOMATIC SWITCH OFF

Cruise control will switch off but the set speed will remain in the memory when:

- The **CANCEL** button (2) is pressed.
- The brake pedal is pressed.
- Speed falls below 30 km/h (18 mph).
- Neutral, Park or Reverse gear is selected.
- Dynamic Stability Control is operating.
- The difference between the actual and set speed is too great.
- When the vehicle reaches a maximum speed of 192 km/h (120 mph).
- The accelerator pedal is used to accelerate beyond the set speed for too long a period.

Cruise control will switch off and clear the memory when:

- The ignition system is switched off.
- A fault occurs. The cruise control system will switch off and cannot be used until the fault is cleared.

Adaptive cruise control

ADAPTIVE CRUISE CONTROL OVERVIEW

The Adaptive Cruise Control (ACC) system is designed to aid the driver to maintain a gap from the vehicle ahead or a set road speed if there is no slower vehicle ahead. ACC is available at vehicle speeds of 32 to 180 km/h (20 to 112 mph).

⚠ ACC is not a collision warning or avoidance system. Additionally, ACC will not react to:

- **Stationary or slow moving vehicles below 10 km/h (6 mph).**
- **Pedestrians or objects in the roadway.**
- **Oncoming vehicles in the same lane.**

The ACC system uses a radar sensor, which projects a beam directly forward of the vehicle to detect objects ahead.

The radar sensor is mounted in the centre of the lower bumper, to provide a clear view forward for the radar beam.

- Only use ACC when conditions are favourable (i.e. main roads with free flowing traffic).
- Do not use in poor visibility, specifically fog, heavy rain, spray or snow.
- Do not use on icy or slippery roads.
- It is the drivers responsibility to stay alert, drive safely and be in control of the vehicle at all times.
- Keep the area in front of the radar sensor free from dirt, metal badges or objects, including vehicle front protectors, which may prevent the sensor from operating.
- Do not use ACC when entering or leaving a motorway.

USING ACC

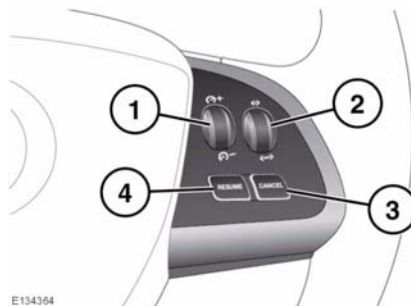

1. **SET:** Roll the thumbwheel upward or downwards to increase or decrease speed, until the desired speed is achieved.
2. Gap increase or decrease control. Four settings are selectable by rolling the thumbwheel. See **98, CHANGING THE FOLLOW MODE SET GAP.**
3. **CANCEL:** Cancels but retains the set speed in memory.
4. **RESUME:** Resumes the ACC set speed after it has been disengaged.

The system is operated by controls mounted on the steering wheel. The driver can also intervene at any time by use of the brake or accelerator pedals.

Setting the vehicle speed, activating, and deactivating ACC is done in the same way as using cruise control.

ENTERING FOLLOW MODE



When in follow mode, the vehicle will not decelerate automatically to a stop, nor will the vehicle always decelerate quickly enough to avoid a collision.

Note: Follow mode cannot be disengaged independently from the speed maintenance aspect of cruise control.

Once a set speed has been selected, the driver can release the accelerator and the set road speed will be maintained.

When a vehicle ahead enters the same lane or a slower vehicle is ahead in the same lane, the vehicle speed will be adjusted automatically until the gap to the vehicle ahead corresponds to the default gap setting (gap level 3). The vehicle is now in **follow mode**.



The amber warning lamp in the instrument panel will be illuminated.

The message centre will display the gap set.



E134363

The vehicle will then maintain the constant time gap to the vehicle ahead until:

- The vehicle ahead accelerates to a speed above the set speed.
- The vehicle ahead moves out of lane or out of view.
- A new gap distance is set.

If necessary, the vehicle brakes will be automatically applied to slow the vehicle to maintain the gap to the vehicle in front.

The maximum braking which is applied by the ACC system is limited and can be overridden by the driver applying the brakes, if required.

Note: Driver braking will cancel ACC.

If the ACC system predicts that its maximum braking level will not be sufficient, then an audible warning will sound while the ACC continues to brake. **Driver Intervene** will be displayed on the message centre. The driver should take immediate action.

When in follow mode, the vehicle will automatically return to the set speed when the road ahead is clear, for instance when:

- The vehicle in front accelerates or changes lane.
- The driver changes lane to either side or enters an exit lane.

The driver should intervene if appropriate.

Adaptive cruise control

CHANGING THE FOLLOW MODE SET GAP

Four gap settings are available and the selected gap setting will be displayed on the message centre when the gap adjustment control is operated.

Each gap level is indicated by an additional chevron in front of the vehicle icon in the message centre (one chevron (gap level 1) being the shortest, four chevrons (gap level 4) being the longest).

Note: When the ignition is switched off, the gap setting will revert to the default setting (gap level 3) when switched on again.

Note: It is the driver's responsibility to select a gap appropriate to the driving conditions.

OVERRIDING THE SPEED AND FOLLOW MODE



Whenever the driver is overriding the ACC by depressing the accelerator pedal, the ACC will not automatically apply the brakes to maintain separation from any vehicle ahead.

The set speed and gap can be overridden by pressing the accelerator pedal when cruising at constant speed or in follow mode. If the vehicle is in follow mode, the warning lamp will go out when the ACC is overridden by the driver using the accelerator and **CRUISE OVERRIDE** will be displayed on the message centre. When the accelerator is released the ACC function will operate again and vehicle speed will decrease to the set speed, or a lower speed if follow mode is active.

AUTOMATIC LOW SPEED SWITCH-OFF

If the speed of the vehicle decreases below 30 km/h (18 mph), the ACC system will be automatically switched off and the warning lamp will go out.

If the brakes were being applied by the ACC system, they will be slowly released.

This will be accompanied by an audible warning, and **DRIVER INTERVENE** will be displayed on the message centre. The driver must take control.

ACC AUTO OFF

ACC will disengage, but not clear the memory when:

- The **CANCEL** button is pressed
- The brake pedal is pressed
- Neutral (**N**), Park (**P**) or Reverse (**R**) gear is selected
- Dynamic Stability Control activates.

ACC will disengage, and clear the memory when:

- The ignition system is switched off
- Maximum vehicle speed is reached
- A fault occurs in the ACC system.

RESUMING THE SPEED AND FOLLOW MODE

- ❗ **RESUME** should only be used if the driver is aware of the set speed and intends to return to it.

By pressing the **RESUME** button after ACC has been cancelled, for example, after braking, the ACC will become active again provided that the set speed memory has not been erased. The original set speed will be resumed (unless a vehicle ahead causes the follow mode to become active) and the set speed will be displayed in the message centre for four seconds.

HINTS ON DRIVING WITH ACC

The system acts by regulating the speed of the vehicle using engine control and the brakes. Gear changes may occur in response to deceleration or acceleration whilst in ACC.

ACC is not a collision avoidance system. However, during some situations the system may provide the driver with an indication that intervention is required.

An audible alarm will sound, accompanied by the message **DRIVER INTERVENE** if the ACC detects:

- A failure has occurred whilst the system is active
- That using maximum ACC braking only is not sufficient.

Note: ACC operates when the gear selector lever is in position **S** or **D**.

Note: When engaged, the accelerator pedal rests in the raised position. Fully release the pedal to allow normal ACC operation.

Note: When braking is applied by the ACC, the vehicle brake lamps will be switched on although the brake pedal will not move.

DETECTION BEAM ISSUES

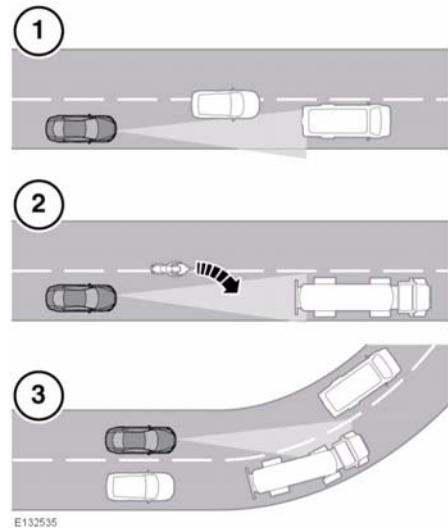

Detection issues can occur:

1. When driving on a different line to the vehicle in front.
2. When a vehicle edges into your lane. The vehicle will only be detected once it has moved fully into your lane.
3. There may be issues with the detection of vehicles in front when going into and coming out of a bend.

In these cases ACC may brake late or unexpectedly. The driver should stay alert and intervene if necessary.

Adaptive cruise control

ACC MALFUNCTION

If a malfunction occurs during operation of the system in cruise or follow modes, the ACC system will switch off and cannot be used until the fault is cleared. The message **Driver Intervene** appears briefly and is then replaced by the message **Cruise Not Available**. If malfunction of the ACC or any related system occurs at any other time, the message **Cruise Not Available** will be displayed. It will not be possible to activate the ACC system in any mode.

Accumulations of dirt, snow or ice on the sensor or cover may inhibit ACC operation. Fitting of a vehicle front protector or metallised badges may also affect ACC operation.

The ACC system relies on its radar to detect objects and constantly scans ahead. If the radar is unable to detect any objects ahead, then ACC will be deactivated, the audible alarm sounds and the message **Driver Intervene** displays briefly. The message **ACC Sensor Blocked** will then be displayed.

The same messages may also be displayed while driving on open roads with few objects for the radar to detect.

Clearing the obstruction from in front of the sensor allows the system to return to normal operation. If the obstruction is present when ACC is inactive (e.g. on initial starting or with the ACC system switched off), the message **ACC Sensor Blocked** will be displayed.

Tyres other than those recommended for your vehicle, may have different sizes. This can affect the correct operation of the ACC.

FORWARD ALERT FUNCTION

Limited detection and warning of objects ahead, is provided during ACC operation by the ACC **Forward Alert** warning. The enhanced forward alert feature additionally provides warnings when ACC is not engaged; if an object is detected close ahead, then the warning tone and message will be issued. The brakes will not be applied.

The forward alert system does not initiate any action. The driver must take appropriate action when the **Forward Alert** message is displayed. However, the system monitors driver actions (e.g. braking, steering or indicating) and may not initiate the warning display if the appropriate action has been taken early enough.

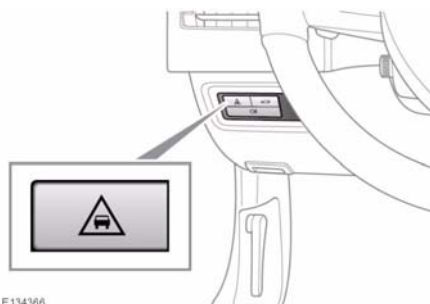

E134366

Press the button to switch Forward alert on or off.



When the warning lamp in the instrument panel is on, Forward alert is active.

The sensitivity of the warning can only be adjusted with ACC disengaged. Adjust as follows:

- Roll the gap adjustment control downwards to decrease the sensitivity of the alert.
- Roll the gap adjustment control upwards to increase the sensitivity of the alert.

Note: The forward alert set gap is retained when the ignition is switched off.

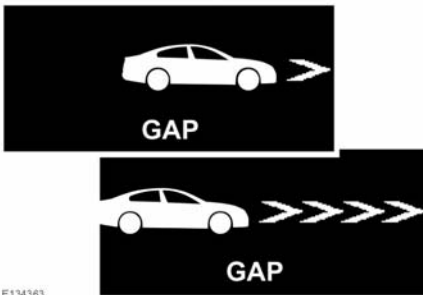

Forward Alert is displayed in the message centre.

ADVANCED EMERGENCY BRAKE ASSIST



The system may not react to slow moving vehicles and will not react to stationary vehicles or vehicles travelling in the opposite direction.



Warnings may not appear if the distance to the vehicle ahead is very small or if steering wheel or pedal movements are large (e.g. to avoid a collision).



The system utilises the same radar sensor as ACC and Forward alert - the same limitations of performance apply.

Advanced emergency brake assist is available at speeds above approximately 7 km/h (5 mph) and improves braking response during emergency braking, when a moving vehicle is detected close ahead.

If the risk of collision increases after the **Forward Alert** warning is displayed, advanced emergency brake assist is activated. The brakes are automatically applied gently in preparation for rapid braking (this may be noticeable). If the brake pedal is then pressed quickly, full braking is implemented, even if only light pressure is applied to the pedal. See **87, EMERGENCY BRAKE ASSIST (EBA)**.

Note: Braking performance will only be improved if the driver applies the brakes.

Advanced emergency brake assist will function even if Forward Alert and ACC are switched off. If there is a fault with the system, **Forward Alert Unavailable** is displayed in the message centre. The vehicle can still be driven and the braking system will still operate, but without advanced emergency brake assistance. Seek qualified assistance to have the fault rectified.

Adaptive cruise control

INTELLIGENT EMERGENCY BRAKING



The system may not react to slow moving vehicles.



The system will not react to stationary vehicles, or vehicles that are not travelling in the same direction as your vehicle.



Warnings and automatic braking may not occur if the distance to the vehicle ahead is very small, or if the steering wheel and pedal movements are large (to avoid a collision for example).



IEB (Intelligent Emergency Braking) uses the same radar sensor as Adaptive Cruise Control and Forward Alert. The same performance limitations apply, see 96, ADAPTIVE CRUISE CONTROL OVERVIEW.

IEB is available at all speeds to automatically apply the brakes if an unavoidable collision with a moving vehicle in front is detected.

If there is an imminent risk of collision, an audible warning is given. If the collision then becomes unavoidable, the IEB system applies the brakes at up to maximum pressure. After IEB has activated, **IEB System Was Activated** is displayed in the message centre and the system is inhibited from further operation until reset by a Dealer/Authorised Repairer.

IEB will function even if Forward Alert and ACC are switched off. If the radar sensor is blocked, by snow or heavy rain for example, or there is a fault with the system, **IEB Not Available** is displayed in the message centre. The vehicle can still be driven and the braking system will still operate, but without IEB. If the cause of this message being displayed is thought to be other than a blocked radar sensor, consult your Dealer/Authorised Repairer.

USING ASL



In certain conditions, such as a steep downhill gradient, the vehicle speed may exceed the set speed limit. This is because engine braking is unable to maintain or reduce the vehicle speed.

The **ASL** button allows the driver to select between cruise control and the automatic speed limiter. The ASL can be set to any speed between 30 km/h (18 mph) and 240 km/h (150 mph).

Note: *Although ASL only operates at speeds between 30 km/h (18 mph) and 240 km/h (150 mph), the maximum speed can be set when the vehicle is stationary.*

SETTING A SPEED LIMIT

- Press the **ASL** button.
- Use the cruise control speed adjustment control to set the required speed. The message centre display in the instrument panel will show the selected speed.
- The set speed can be adjusted at any time, using the cruise control speed adjustment control.

When ASL is selected and a set speed inserted, the engine will respond normally up to the set speed. Further accelerator pedal pressure will not increase the vehicle speed beyond your set speed, unless kickdown is initiated, in which case ASL will be suspended.

SUSPENDING ASL

ASL can be suspended by pressing the **CANCEL** button. Applying sudden, rapid acceleration (kickdown) will also suspend ASL.

RESUMING ASL

If ASL has been suspended, it can be reinstated with a single press of the **RESUME** button, however, ASL will only reinstate if the vehicle speed is less than the current speed set in memory and greater than 30 km/h (18 mph). The message centre will display an appropriate message if the vehicle speed is too fast to resume ASL.

ASL WARNING LAMP



Illuminates (amber) when Automatic Speed Limiter is active.

Audio/video overview

AUDIO/VIDEO CONTROLS

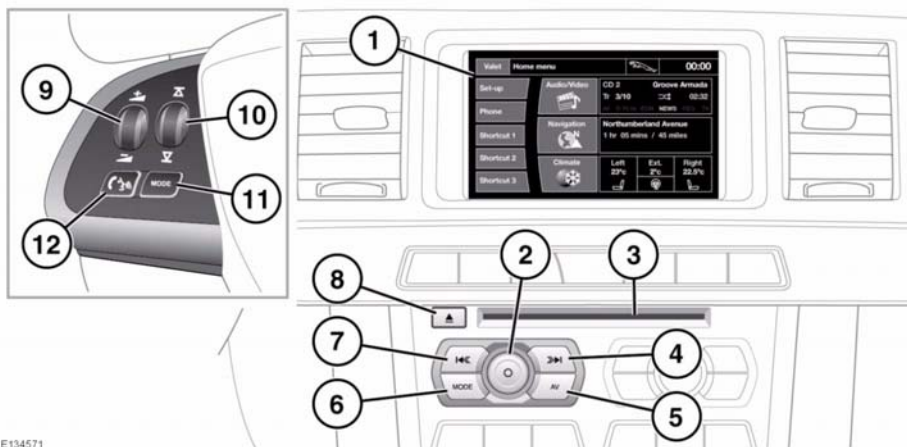

E134571



Sustained exposure to high sound levels (greater than 85 decibels) can damage your hearing.

1. Touch screen.
2. Press to switch the audio system on/off. Rotate to adjust volume level.

Note: The audio system will operate with the ignition on or off, but will switch off with the ignition. Switch the audio on again if required. The system will remain on for approximately 10 minutes.

3. CD/DVD loading slot.

The player will accommodate one disc at a time, but up to 10 CDs can be uploaded into the CD store. Only CDDA discs can be uploaded into the CD store.

4. Seek up:

Short press:

- To auto seek up the frequency to the next radio station.
- To select the next track on chosen audio source - CD, MP3 etc.

- To select the next TV channel on the channel list or the next DVD chapter.

Long press:

- To activate radio manual seek mode.
- To scan forwards through the current audio source track.

With radio manual seek mode activated, further short presses will change the frequency in single increments. A further long press will scan forwards through the current waveband until the button is released.

5. **AV** (Audio/Video). Press for direct access to the **Audio/Video** menu.

Audio/Video options can include Radio, DAB radio, CD, stored CD, MP3, USB, iPod, AUX, DVD, TV and RSE.

6. **MODE**: Press repeatedly to scroll through all audio/video sources.

7. Seek down:

Short press:

- To auto seek down the frequency to the next radio station.
- To select the previous track or start of current track on chosen audio source - CD, MP3 etc.
- To select the previous TV channel on the channel list or the previous DVD chapter.

Long press:

- To activate radio manual seek mode.
- To skip backward through current audio source track.

With radio manual seek mode activated, further short presses will change the frequency in single decrements. A further long press will scan backward through the current waveband until the button is released.

8. CD/DVD eject button.

9. Rotate to adjust volume.

10. Rotate (up or down) and release repeatedly to scroll through:

- The radio presets.
- The previous track or start of next track on chosen audio source - CD, MP3 etc.

11. **MODE**: Press repeatedly to scroll through all audio/video sources.

12. If Telephone and Voice control are not fitted, press to mute/un-mute audio.

Otherwise, if Telephone is fitted, see **128, TELEPHONE SYSTEM OVERVIEW**. If Voice control is fitted, see **126, USING VOICE CONTROL**.

AUDIO SETTINGS

To view the audio settings menu, select **Settings** and then **Sound** on the touch screen.

To adjust the sound settings:

1. Touch the **+** or **-** soft keys to adjust Bass, Treble or Subwoofer levels.
2. If surround sound is fitted, touch the appropriate soft key to select **DPL II X**, **DTS Neo6** or select **Off** to switch surround sound off.

To adjust balance and fade:

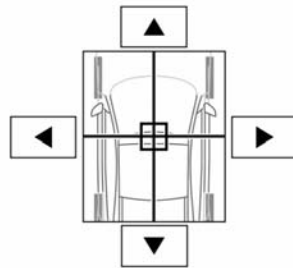

E132537

1. From the Sound settings menu, select **Balance/Fade**.

2. Touch the arrow soft keys to move the sound focal point to the desired area of the vehicle (the focal cross-hairs will appear red when not in the default position). Alternatively, touch the sound focal point and 'drag' it to the required position.

Audio/video overview

LICENSING



E132527



E132539

Manufactured under license from Dolby Laboratories.

Dolby, Pro Logic, and the double-D symbol are registered trademarks of Dolby Laboratories.



E132540

Manufactured under license under U.S. Patent #'s: 5,451,942; 5,956,674; 5,974,380; 5,978,762; 6,487,535; 7,003,467 & other U.S. and worldwide patents issued & pending. DTS, the Symbol, and Neo:6 are registered trademarks, & DTS Digital Surround and the DTS logos are trademarks of DTS, Inc. Product includes software. © DTS, Inc. All Rights Reserved.



E132541



E132542

Manufactured under license under U.S. Patent #'s: 5,451,942; 5,956,674; 5,974,380; 5,978,762; 6,487,535 & other U.S. and worldwide patents issued & pending. DTS and the Symbol are registered trademarks, & DTS 2.0+ Digital Out and the DTS logos are trademarks of DTS, Inc. Product includes software. © DTS, Inc. All Rights Reserved.



E132543

DivX Certified® to play DivX® video.

DivX®, DivX Certified® and associated logos are registered trademarks of DivX, Inc. and are used under license.

ABOUT DIVX VIDEO: DivX® is a digital video format created by DivX, Inc. This is an official DivX Certified device that plays DivX video. Visit www.divx.com for more information and software tools to convert your files into DivX video.

ABOUT DIVX VIDEO-ON-DEMAND: This DivX Certified® device must be registered in order to play DivX Video-on-Demand (VOD) content. To generate the registration code, locate the DivX VOD section in the device setup menu.

1. Follow the route, Home Menu - Audio Video - TV/My video - Settings - VOD.
2. An eight digit code will be displayed. This is your unique DivX code. Make a note of this code and keep it for future reference.

Go to <http://vod.divx.com> with this code to complete the registration process and learn more about DivX VOD.

Covered by one or more of the following U.S. Patents: 7,295,673; 7,460,668; 7,515,710; 7,519,274.



E132544

Music and video recognition technology and related data are provided by Gracenote®. Gracenote is the industry standard in music recognition technology and related content delivery. For more information, please visit www.gracenote.com.

CD, DVD, Blu-ray Disc, and music and video-related data from Gracenote, Inc., copyright © 2000 to present Gracenote. Gracenote Software, copyright © 2000 to present Gracenote. One or more patents owned by Gracenote apply to this product and service. See the Gracenote website for a non-exhaustive list of applicable Gracenote patents. Gracenote, CDDb, MusicID, MediaVOCS, the Gracenote logo and logotype, and the "Powered by Gracenote" logo are either registered trademarks or trademarks of Gracenote in the United States and/or other countries.

GRACENOTE® END USER LICENSING AGREEMENT

This application or device contains software from Gracenote, Inc. of Emeryville, California ("Gracenote"). The software from Gracenote (the "Gracenote Software") enables this application to perform disc and/or file identification and obtain music-related information, including name, artist, track, and title information ("Gracenote Data") from online servers or embedded databases (collectively, "Gracenote Servers") and to perform other functions. You may use Gracenote Data only by means of the intended End-User functions of this application or device.

You agree that you will use Gracenote Data, the Gracenote Software, and Gracenote Servers for your own personal non-commercial use only. You agree not to assign, copy, transfer or transmit the Gracenote Software or any Gracenote Data to any third party. **YOU AGREE NOT TO USE OR EXPLOIT GRACENOTE DATA, THE GRACENOTE SOFTWARE, OR GRACENOTE SERVERS, EXCEPT AS EXPRESSLY PERMITTED HEREIN.**

You agree that your non-exclusive license to use the Gracenote Data, the Gracenote Software, and Gracenote Servers will terminate if you violate these restrictions. If your license terminates, you agree to cease any and all use of the Gracenote Data, the Gracenote Software, and Gracenote Servers. Gracenote reserves all rights in Gracenote Data, the Gracenote Software, and the Gracenote Servers, including all ownership rights. Under no circumstances will Gracenote become liable for any payment to you for any information that you provide. You agree that Gracenote, Inc. may enforce its rights under this Agreement against you directly in its own name.

Audio/video overview

The Gracernote service uses a unique identifier to track queries for statistical purposes. The purpose of a randomly assigned numeric identifier is to allow the Gracernote service to count queries without knowing anything about who you are. For more information, see the web page for the Gracernote Privacy Policy for the Gracernote service.

The Gracernote Software and each item of Gracernote Data are licensed to you “AS IS.” Gracernote makes no representations or warranties, express or implied, regarding the accuracy of any Gracernote Data from in the Gracernote Servers. Gracernote reserves the right to delete data from the Gracernote Servers or to change data categories for any cause that Gracernote deems sufficient. No warranty is made that the Gracernote Software or Gracernote Servers are error-free or that functioning of Gracernote Software or Gracernote Servers will be uninterrupted. Gracernote is not obligated to provide you with new enhanced or additional data types or categories that Gracernote may provide in the future and is free to discontinue its services at any time.

GRACENOTE DISCLAIMS ALL WARRANTIES EXPRESS OR IMPLIED, INCLUDING, BUT NOT LIMITED TO, IMPLIED WARRANTIES OF MERCHANTABILITY, FITNESS FOR A PARTICULAR PURPOSE, TITLE, AND NON-INFRINGEMENT. GRACENOTE DOES NOT WARRANT THE RESULTS THAT WILL BE OBTAINED BY YOUR USE OF THE GRACENOTE SOFTWARE OR ANY GRACENOTE SERVER. IN NO CASE WILL GRACENOTE BE LIABLE FOR ANY CONSEQUENTIAL OR INCIDENTAL DAMAGES OR FOR ANY LOST PROFITS OR LOST REVENUES.

© Gracernote, Inc. 2009

RADIO CONTROLS

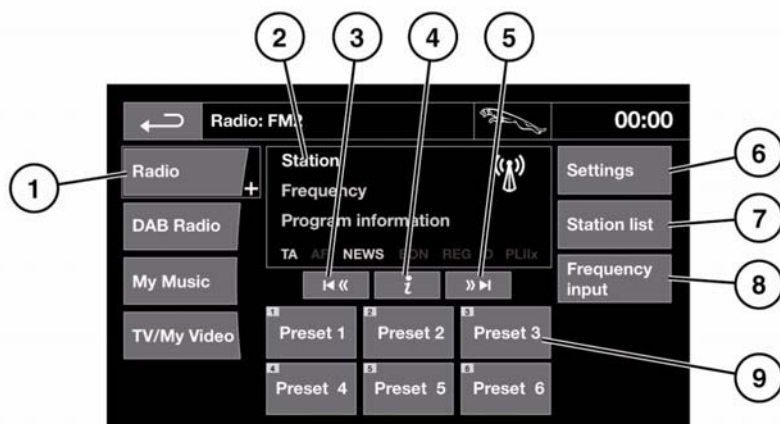

E134932

1. **Radio:** Waveband selection. Touch to view and select a waveband. The radio will tune to the last used station on that waveband. The waveband selection box will close after 5 seconds without use or can be closed manually by selecting **Radio** again.
2. Displays information about the current station. Some of this information is also displayed in the instrument panel.
3. **Seek down:**
 - Short touch to auto seek down the frequency to the next radio station.
 - Long touch to activate manual seek mode. Further short touches change the frequency in single decrements. A further long touch will scan backwards through the current waveband until the soft key is released.
4. **Information.** More information from the broadcasting station.
5. **Seek up:**
 - Short touch to auto seek up the frequency to the next radio station.
 - Long touch to activate manual seek mode. Further short touches change the frequency in single increments. A further long touch will scan forwards through the current waveband until the soft key is released.
6. **Settings:** Touch to view and activate/deactivate the following features: **RDS**, **Traffic**, **News**, **AF** and **REG**. See **110**, **RADIO DATA SYSTEM (RDS)**.
7. **Station list (FM only):** Select to view a list of available stations on the waveband. The list can be sorted by **Frequency**, **Name** or **PTY** (pop, news, sport etc.), by selecting the appropriate soft key. Touch to select the chosen station.
If the stations are sorted by category, touch the chosen category to view and select a corresponding station.

8. **Frequency input:** Select to enter a known frequency of a station on the current waveband, using the numeric keypad that appears. Select **OK** or wait for 2 seconds to tune to the entered frequency.
9. **Station presets:** Each waveband has 6 preset positions.
 - Touch and release to tune to the station stored on that preset.
 - Touch and hold to store the current station on that preset (the radio will mute while the station is stored then beep).
 - Use the seek buttons on the steering wheel to change to the next or previous preset station.

RADIO DATA SYSTEM (RDS)

Your radio is equipped with RDS which enables the audio unit to receive additional information with normal FM radio signals.

Note: *Not all FM radio stations broadcast RDS information.*

Select **Settings** (6) to view or alter RDS settings.

- **Traffic/News:** Provides local travel or news information.
- **Regionalisation (REG):** Select to prevent the radio tuning into an alternative local station that has a stronger signal.
- **Alternative Frequency (AF):** Select to allow the radio to automatically re-tune to a stronger alternative frequency for the current station. This is useful on a journey where the vehicle travels through different transmitter areas.

DAB RADIO CONTROLS

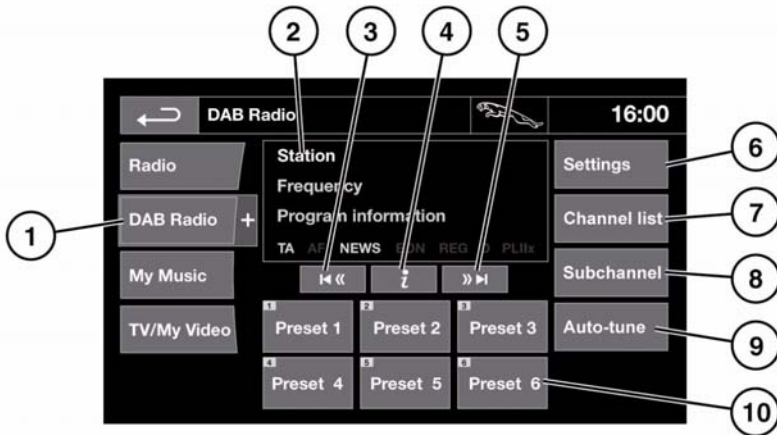

E134935

1. **DAB Radio:** Touch to view and select a DAB band (**DAB 1, 2 or 3**). The radio will tune to the last used channel on that band. Touch again to close.
The DAB band selection box will close automatically after 5 seconds without use.
2. Indicates currently selected DAB band (**DAB1, 2 or 3**).
3. Seek down:
 - Short touch to seek previous available channel.
 - Long touch to seek previous available Ensemble. The first channel in the new Ensemble will be selected.
4. Channel information: Touch to view DAB text and channel information.
5. Seek up:
 - Short touch to find the next available channel.
 - Long touch to find the next available Ensemble. The first channel in the new Ensemble will be selected.
6. **Settings:** Touch to view the DAB Settings menu:
 - **Options:** To activate/deactivate FM Traffic and Link DAB and to alter DAB country and format settings (with vehicle stationary).
 - **Announcements:** Select an alarm announcement and up to 3 other announcement types (traffic, news etc.) from the list. The selected announcements will interrupt the current programme when broadcast.

7. **Channel list:** Touch to view a list of available Ensembles and channels. The list can be sorted by **Ensemble**, **Channel**, **Subchannel** or by **Category**.

- If an **Ensemble** is selected from the list, all available channels from that ensemble will be displayed.
- Sorting by **Subchannel** is only available when the current channel is broadcasting subchannels.
- If **Category** is selected, touch the chosen category to view corresponding channels, before making your selection from the list.

Once the desired selection has been made, select the Back soft key to return to the main DAB menu.

8. **Subchannel:** If subchannels are broadcast by the current channel, this soft key will be active. Select to allow subchannels then select the required subchannel with the seek down / up keys.

9. **Auto-tune:** Select to scan for all available DAB Ensembles/channels. This needs to be done before using the DAB radio for the first time.

Auto-tune is also useful when travelling long distances, so regional Ensembles can be tuned.

During Auto-tune, a pop-up shows tuning progress.

The Auto-tune process will not affect current presets, but some presets may not operate if the channel they relate to is no longer available (**No reception** displays).

10. **Station presets:** Each DAB band has 6 preset positions.

- Touch and release to tune the radio to the station stored on that preset.
- Touch and hold to store the current station on that preset (the radio will mute while the station is stored).
- Use the seek buttons on the steering wheel to select the next or previous preset station.

Note: *If you attempt to select a preset channel that is now unavailable or invalid, **No reception** is displayed.*

DIGITAL RADIO RECEPTION

DAB radio can significantly increase the number of radio channels/stations available. The DAB signals are transmitted to most major cities, towns and motorway networks.

Digital radio is transmitted from regional transmitters. Some local channels are not available outside the range of their transmitters. If you want to listen to local channels as you move around the country, use the auto-tune function (AUTO) to build new channel lists.

Note: *If any auxiliary electrical equipment is connected to the vehicle, then this may reduce the DAB radio sound quality.*

ENSEMBLES

Unlike AM/FM radio, DAB transmits several channels/stations on a single frequency. A group of channels is known as an ensemble. Some channels within the ensemble may have subchannels offering several listening options.

If reception is lost when the vehicle is in motion, the vehicle may be out of range of the ensemble. To build a new list of ensembles, select **Auto-tune**.

PORTABLE MEDIA CONNECTIONS

Portable media devices can be connected to the media hub located in the cubby box. Compatible portable devices include:

- USB mass storage devices (e.g. a memory stick). Devices must use FAT or FAT32 file format.
- iPod (iPod Classic, iPod Touch, iPhone and iPod Nano are supported - full functionality for older devices cannot be guaranteed). iPod Shuffle functionality cannot be guaranteed.

Note: *iPod and iPhone are trademarks of Apple Inc., registered in the USA and other countries.*

- Auxiliary device (personal audio, MP3 players, all iPods).

Note: *Auxiliary devices have no touch screen control.*

If you are connecting an iPod, mass storage or Bluetooth® device, use the touch screen to operate and search the device. Many of the controls are similar to those available for CD play.

- ⚠ Please disconnect your iPod when leaving the vehicle. Failure to do so may result in the iPod battery discharging.

Note: *The audio system will play MP3, WMA and AAC files.*

To maximise playback quality, it is recommended that lossless compression is used for any media files on USB or iPod. Failing this, it is recommended that compressed files utilise a minimum bitrate of 192 kb/s (a higher bitrate is strongly recommended).

Note: *Some MP3 players have their own file system that is not supported by this system. To use your MP3 player, you must set it to USB Removable Device or Mass Storage Device mode. Only music that has been added to the device in this mode can be played.*

CONNECTING A DEVICE

- ⚠ Always refit the rubber cover when a portable device is not plugged in. This prevents damage to the sockets. The cover is not waterproof.

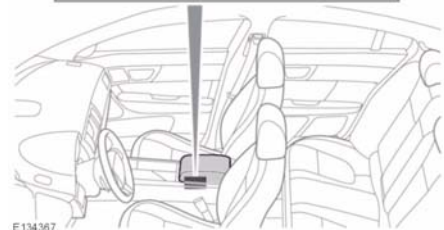
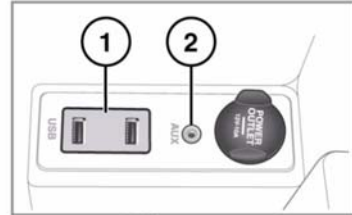

E134367

1. USB sockets.
2. Auxiliary socket (AUX).

Connect the device into the appropriate socket.

When an iPod is connected, playback will continue from the point at which it was last playing, provided the iPod battery is in a good state of charge.

When a USB or Bluetooth® device is connected, playback will continue from the point it was last played. If a device is already connected when **AUX** is selected, playback will continue from the point at which it was last playing.

Please refer to the Ownership section of the Jaguar website at www.jaguar.com, for a list of compatible devices.

Portable media

The Bluetooth® equipped devices listed on Jaguar.com have been tested for compatibility with Jaguar vehicles. Performance will vary, based on the device's software version and battery condition. Devices are warranted by their manufacturer, not Jaguar.



Do not plug non-audio devices into the USB port.

Note: *You cannot use a USB hub to connect more than one USB device to the audio unit.*

Note: *Devices connected to the USB ports will be charged, but devices that are fully discharged will not play.*

Note: *Options such as **Repeat** and **Mix** relate to the device currently playing, they will not apply to any subsequent device.*

PORTABLE MEDIA CONTROLS

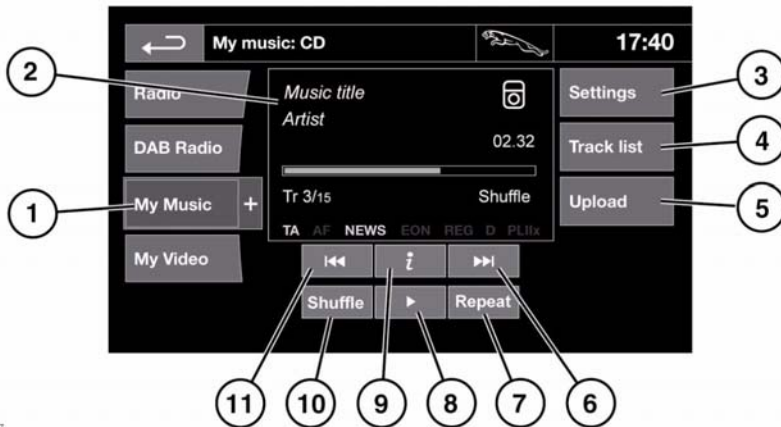

E134937

My Music includes CD, iPod, USB, AUX and Bluetooth devices. The full infotainment system also includes Stored CD.

1. Touch the **My Music +** icon to display all options. Select an option.

Note: Sound quality and volume levels available from devices connected to the auxiliary input may vary widely.
2. Display of information about the current track, including elapsed run-time. Some of this information is also displayed in the instrument panel.
3. **Settings:** Select to switch traffic and news announcements on or off. Additionally, for MP3 recorded media, you can select the number of list entries that are skipped when you use the page up/down arrows when navigating a list.
4. Depending on the selected mode, this soft key will be either **Track list** or **Browse**. In Stored CD mode, both soft keys will be displayed.

Track list. Select to view current CD or Stored CD track list. Select a track to start playback.

Browse. (iPod, USB and Stored CD modes only).

- Select to view the contents of the connected device which are displayed as dictated by the file structure.
 - Select a file to start playback (Browse view will remain). Select a folder or subfolder to view their contents.
 - To return to the Controls menu, select the Back soft key.
5. **Upload:** Applicable to Stored CD menu only.

Select to view and manage the CDs loaded onto the CD store.

 - Select **Upload** alongside an empty slot to upload the current CD. There are 10 slots available.
 - If the CD store is full, select **Replace** to overwrite an existing CD.

Portable media

In each case a confirmation pop-up will appear. Select **Yes** to continue.

Note: Loading time is dependent on content type. A % count up is displayed. Other features can be selected while upload is in progress.

6. Skip/Scan forward:

- Touch and release to skip to the next track.
- Touch and hold to scan forwards through the current track. Play will resume when the soft key is released.

7. Repeat:

In **CD** mode

- Touch and release to repeat the current track continuously until Repeat mode is cancelled. **Repeat track** is displayed.
- Touch and release again to repeat the current Stored CD (or folder for MP3 discs) continuously until Repeat mode is cancelled. **Repeat disc** or **Repeat folder** is displayed.
- Touch and release a third time to cancel Repeat mode.

Note: Selecting **Shuffle (10)** will cancel Repeat mode, but **Repeat track** can be selected with Shuffle mode active (cancels the previously selected shuffle mode).

In **USB** or **iPod** mode

- Select to repeat the current track.
- Select again to repeat the current folder (USB) or to cancel repeat mode (iPod). Select again to cancel repeat mode in USB.

Note: Repeat mode is not available for Bluetooth® devices.

Note: Selecting **Shuffle (10)** will cancel Repeat mode.

8. Pause/Play: Select to pause playback. Select again to resume playback.

9. Information. More information about the current track.

10. Shuffle:

- Touch and release once to play random tracks from the current CD, MP3 folder, USB folder or iPod playlist. A **Shuffle** message is displayed.
- Touch and release again to play random tracks from CD, MP3 disc, USB folders or tracks on the media device or tracks loaded onto the CD store. **Shuffle all** is displayed.
- Touch and release again to cancel Shuffle mode

Note: Shuffle mode is not available for Bluetooth® devices.

11. Skip/Scan backward:

- Touch and release within 3 seconds of track playback to skip to the previous track.
- Touch and release after 3 seconds of track playback to skip to the beginning of the current track.
- Touch and hold to scan backwards through the current track. Playback will resume when the soft key is released.

PLAYING A PORTABLE DEVICE

If you are using a USB mass storage device or approved iPod, you can control playback using the touch screen controls.

If you are using a Bluetooth® device, you can control playback using the touch screen, but some controls are unavailable.

If you are using any portable media device via the AUX socket, then you must control playback from the device itself.



Jaguar does not recommend the use of a Hard Disc Drive via the USB link while the vehicle is in motion. These devices are not designed for in car use and may be damaged.

CONNECTING MULTIPLE DEVICES



Do not plug non-audio devices into the USB port.

You can connect multiple devices simultaneously to the portable media interface and switch between them using the touch screen. Select **iPod**, **USB**, **Bluetooth** or **AUX**, to switch between modes.

The device docked first will remain the active device until you choose to change.

If, after changing to the newly-docked device, you change back to the first device, play will resume at the point you left it (USB and iPod only).

Note: You cannot use a USB hub to connect more than one USB device to the audio unit.

Note: Devices connected to the iPod and USB ports will be charged, but devices that are fully discharged will not play.

Note: Options such as **Repeat** and **Shuffle** relate to the device currently playing, they will not apply to any subsequent device.

PAIRING AND CONNECTING USING THE MEDIA PLAYER

For further information on Bluetooth®, see **129, BLUETOOTH® INFORMATION**.

Note: The process of pairing and connecting your media device with the vehicle, using the media device, will vary depending on the type of media device.

1. Switch on the ignition and ensure the touch screen is active.
2. From the Home menu, select **Audio/Video**, then **My Music**.

3. A menu will appear. Select **Search new**.

4. Select **Device to vehicle** option.

Note: The vehicle's Bluetooth® system is only discoverable for 3 minutes.

5. Using the media device, search for Bluetooth® devices. On some media devices, this is referred to as new paired device. See your media device's operating instructions for further information.
6. When the vehicle's Bluetooth® system is discovered, follow the on-screen instructions. Select **Yes** when prompted, to confirm the pairing.

Either your device or the vehicle system will ask for a PIN (Personal Identification Number). When prompted, enter a PIN of your choice and select **OK** to confirm.

7. Enter the same PIN into the other device.
8. Once your device is paired and connected to the system, a confirmation message will be displayed, before switching to the My music: Bluetooth screen.

Note: Some media devices do not automatically connect and need to be manually connected, via the device or by using the **Change device** option.

PAIRING AND CONNECTING A BLUETOOTH® DEVICE USING THE TOUCH SCREEN

For further information on Bluetooth®, see **129, BLUETOOTH® INFORMATION**.

1. Switch on your device's Bluetooth® connection. Make sure that it is in Bluetooth® discoverable mode, sometimes referred to as find me mode (see your device's operating instructions for more information).
2. Switch on the ignition and ensure the touch screen is active.
3. From the Home menu, select **Audio/Video**, then **My Music**.
4. A menu will appear. Select **Search new**.
5. Select **Vehicle to device** option.
6. Identify your device from the displayed list and select the corresponding **Pair and connect** option.

***Note:** If more than 5 devices are detected, it may be necessary to use the scroll bar to see the entire list.*

7. When prompted, enter the PIN (Personal Identification Number) code into your device. See your device's operating instructions for more information.
8. Once your device is paired and connected to the system, a confirmation message will be displayed before switching to the My music: Bluetooth screen.

***Note:** Due to the duration of a Bluetooth® search, it is advised that the time-out to home screen feature is switched off before attempting to search for Bluetooth® devices. This setting can be changed within **Set-up, Screen, Time out home**.*

AUTOMATIC BLUETOOTH® RECONNECTION

If devices have already been paired and connected, when Bluetooth® is selected from the My music menu, the system will automatically connect to the last used device (a confirmation pop-up appears). If the last used device is not present, then the system will search for other previously connected devices and automatically connect if one is found.

If no previously connected device is found, **Please connect device** is displayed and the **Change device** option is given.

LOSS OF CONNECTION

If a loss of connection between the vehicle and the Bluetooth® device occurs, a pop-up is displayed. Select **Reconnect** to automatically restore the connection. A confirmation pop-up will appear before the touch screen reverts to its previous mode.

CHANGING/DISCONNECTING A DEVICE

1. From the menu, select **Change device**.
2. Select **Disconnect**. A confirmation pop-up will appear and then you will be given the option to **Search new** or select a different device from the list of paired devices.

LOADING COMPACT DISCS

- ⓘ Do not force the disc into the slot.
- ⓘ Do not use irregular shaped CDs and CDs with a scratch protection film or self-adhesive labels attached.
- ⓘ The CD unit will play compact discs that conform to the international Red Book standard audio specification. Playback of CDs not conforming to this standard cannot be guaranteed.
- ⓘ Recordable (CD-R) discs and re-writable (CD-RW) discs may not function correctly.
- ⓘ Dual format, dual-sided discs (DVD Plus, CD-DVD format) are thicker than normal CDs and consequently playback cannot be guaranteed and jamming may occur.

It is recommended that only high quality 12 cm (4.7 in.) circular discs are used.

The unit will play Compact Disc Digital Audio (CDDA) discs, MP3, WMA, WAV and AAC files.

The CD player will accommodate one disc at a time, but up to 10 CDs can be uploaded into the CD store. Only CDDA discs can be uploaded into the CD store.

To locate the CD load slot and the eject button, see **104, AUDIO/VIDEO CONTROLS**.

MP3 FILE PLAYBACK

If an MP3 CD is to be used, each session must be properly closed but the whole disc does not have to be finalised.

When Browse is selected, the list of folders and MP3 files is displayed. Select a folder to view and select the tracks contained within.

- The highest compression rate supported is 320k bits per second (kbps). If anything less than 128 kbps is used, Digital Signal Processing (DSP) functionality may be lost.
- The CD player may take a longer time to load an MP3 disc if there are more tracks than on a normal CD. To minimise loading time, a rigid folder structure is recommended.
- If a CD contains a mixture of MP3 and CDDA tracks, any MP3 tracks will be ignored.

CD PLAYER CONTROLS

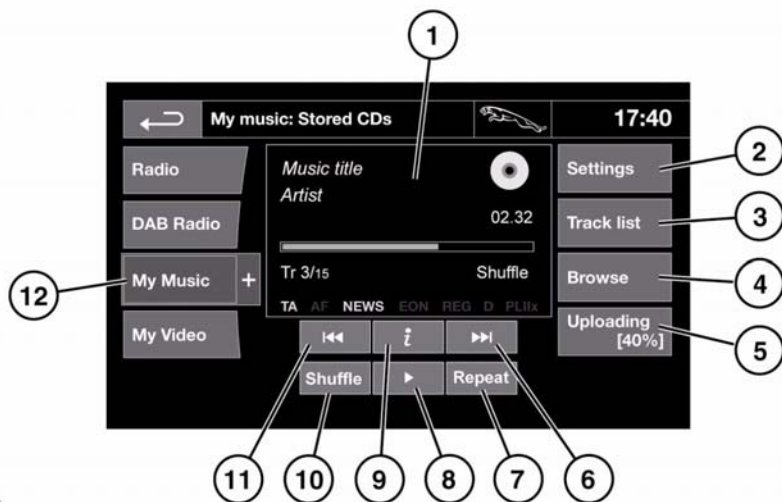

E134941

1. Display of information about the current track, including elapsed run-time. Some of this information is also displayed in the instrument panel.
2. Select to switch traffic and news announcements on or off.
3. Select to view the track list of the current CD or Stored CD. Select a track from the list to start playback. This is displayed as a Browse soft key on some screens.
4. Select to view and manage the CDs in the CD store.
 - Select **Upload** alongside an empty slot to upload the current CD.
 - If the CD store is full, select **Replace** to overwrite an existing CD.In each case a confirmation pop-up will appear. Select **Yes** to continue.
5. Shows progress of upload to the CD store.
6. Skip/Scan forward:
 - Touch and release to skip to the next track on the current CD.
 - Touch and hold to scan forwards through the current track. Playback will resume when the soft key is released.
7. Repeat:
 - Touch and release once to repeat the current track continuously until Repeat mode is cancelled. **Repeat track** is displayed.
 - Touch and release again to repeat the current Stored CD (or folder for MP3 discs) continuously until Repeat mode is cancelled. **Repeat disc** is displayed.
 - Touch and release a third time to cancel Repeat mode.

Note: Selecting **Shuffle** will cancel Repeat mode but **Repeat track** can be selected with Shuffle mode active (cancels the previously selected shuffle mode).

8. Pause/Play: Select to pause playback.
Select again to resume playback.
9. Select to view more detailed information about the current track.
10. Shuffle:
 - Touch and release once to play random tracks on the current CD (MP3 folder). **Shuffle disc** is displayed.
 - Touch and release again to play random tracks from all Stored CDs (MP3 disc). **Shuffle all** is displayed.
 - Touch and release a third time to cancel Shuffle mode.
11. Skip/Scan backward:
 - Touch and release within 3 seconds of track playback to skip to the previous track.
 - Touch and release after 3 seconds of track playback to skip to the beginning of the current track.
 - Touch and hold to scan backwards through the current track. Playback will resume when the soft key is released.
12. Touch to select playback from either the current CD or from CDs uploaded onto the CD store. Selection of portable media device playback is also made from this menu. See **115, PORTABLE MEDIA CONTROLS**.

TELEVISION CONTROLS

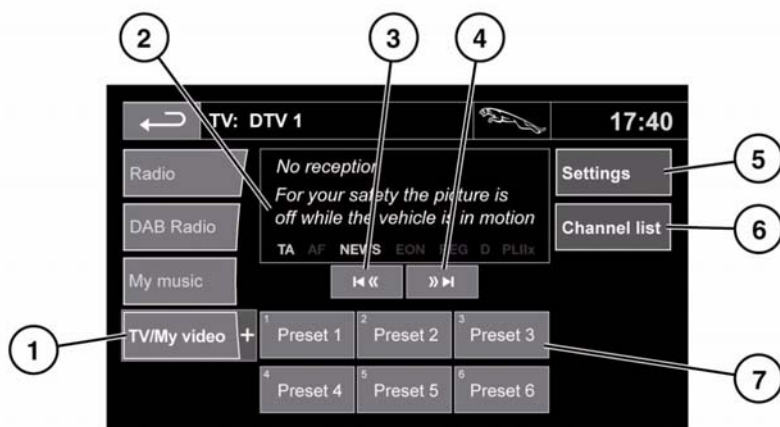

E134946

- 1. TV/My video:** TV band/video input selection:

Touch the + icon to view and select either digital (**DTV 1** or **DTV 2 - Digital**) or analogue (**TV - Analogue**) TV reception.

When changing between analogue and digital bands, this will cause the last tuned channel on the new band to be displayed. When changing between digital bands, the current channel will be displayed.

Note: After 5 seconds without use, the TV/My video menu will close.
- 2. Preview screen for TV program:** Touch to select full screen mode.

Short touch the screen again to view the controls and Electronic Programme Guide (EPG) information at any time.

To return to preview mode, touch and hold the full screen view.
- 3. Seek down:** Select to view the previous channel on the TV channel list.
- 4. Seek up:** Select to view the next channel on the TV channel list.
- 5. Settings:** Select to switch Traffic and News announcements on or off, or to select an alternative country analogue TV format, if necessary, when travelling abroad.

Note: Digital TV is not affected by a change of country.
- 6. Channel list:** Select to view an alphabetical list of all TV channels currently available.
 - A small preview of the current channel and program title is also displayed.
 - Touch a listed channel to change the preview and title to the new channel.
 - Touch the preview to view that channel.

Note: As the TV system is continually checking the availability of channels, it is possible for a channel to be in the list, but not actually available (e.g. when driving through different transmitter regions).

After a country format change, the channel list will be empty until the system has scanned all channels at least once.

7. TV channel presets:

- Long touch to store the current channel as a preset. The channel name will then be displayed on the soft key.
- Short touch to select the channel stored on that preset.

***Note:** Stored presets contain information identifying the country where the preset was stored. When a stored preset is selected, the TV format of that country will be adopted. As analogue TV formats differ in different countries, this may create a situation where the analogue channel list is empty.*

For information on the use of the audio/video controls, on the audio unit and steering wheel, see **104, AUDIO/VIDEO CONTROLS**.

ANALOGUE/DIGITAL TELEVISION

The TV offers both analogue and digital TV reception. You can switch between the two modes using the touch screen controls.

- From the TV/My video menu, select **TV/My video** again or touch the + button alongside.
- Select the desired option from **DTV 1** or **DTV 2 - Digital** or **ATV - Analogue**. There is no difference in the reception mode between DTV 1 and DTV 2. The preset list is the only thing that changes.

Video media player

VIDEO MEDIA PLAYER CONTROLS



E134949

1. **TV/My video:** TV band/video input selection.

Touch the + icon to view and select DVD or other forms of video media (CD/USB), provided the relevant media is present. The selected option will be displayed.

Note: After 5 seconds without use, the TV/My video menu will close.

2. Preview screen for video media information: Touch to select full screen mode.
Short touch the screen again to view the controls at any time.
To return to preview mode, touch and hold the full screen view.
3. **Settings:** Depending on the video media specification, there are 2 sub-menus within settings: **Options** and **VOD** (Video On Demand).
VOD allows playing of DivX VOD content from a video media. The eight digit registration code will be displayed when the VOD soft key is touched.

The player must also be registered with DivX. See **106, LICENSING**.

4. **Tools:** The following options can be selected:
 - **GOTO:** The GOTO menu allows you to access specific parts of the video, by **Chapter** or **Title number**.
 - Subtitles.
 - Angle.
 - Audio.
5. **Menu:** Select to view the Video media menu. On some screens this may be replaced by a **Browse** soft key.
6. **Seek up:** Select to view the next DVD chapter or previous chapter of the video media.
7. Select to start/restart play.
8. **Seek down:** Select to view the previous DVD chapter or previous chapter of the video media.

For information on the CD/DVD loading slot and eject button, and the use of the audio/video controls on the audio unit and steering wheel, see **104, AUDIO/VIDEO CONTROLS**.

LOADING DVDs

- ⓘ Do not force the disc into the slot.
- ⓘ Do not use irregular shaped DVDs and DVDs with a scratch protection film or self-adhesive labels attached.
- ⓘ Recordable (DVD-R or DVD+R) discs may not function correctly.
- ⓘ Dual format, dual-sided discs (DVD Plus, CD-DVD format) are thicker than normal CDs and consequently playback cannot be guaranteed, and jamming may occur.

It is recommended that only high quality 12 cm (4.7 in.) circular discs are used.

To locate the DVD load slot and the eject button, see **104, AUDIO/VIDEO CONTROLS**.

VIDEO MEDIA INHIBIT WITH VEHICLE MOVING

When the vehicle is moving the video picture will automatically be inhibited. The touch screen will display the **TV/My video** screen and the relevant safety message will be displayed.

FULL SCREEN VIEW CONTROLS

When full screen mode is selected, the seek controls operate in the same manner as they do in preview mode.

Display format: Use the relevant soft key to select the **4:3**, **16:9** or **Zoom** option.

Digital TV display format: The picture can be displayed in either the correct format as transmitted by the broadcaster (either **4:3** or **16:9**) or select **Zoom** to magnify the picture.

Voice control

USING VOICE CONTROL

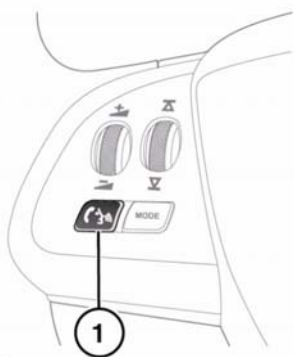

E135492

1. Phone/Voice control button: When there is no phone entry highlighted and no call in progress, press and release to start a voice session. A pop up will appear on the touch screen. Press and hold to cancel a voice session.

Note: Briefly press the Voice button during a voice session, to interrupt audible feedback. Wait for the tone to sound before giving the next command.

2. Voice symbol: Indicates that a command is available. Wait for the symbol to appear and a tone to sound before using the command.
3. Command list: Appears on the pop up panel, providing feedback and available commands at each stage of the voice session. Say an available command.

Note: As the commands are listed before the system is ready to listen, it is important to wait for the voice symbol to appear alongside the relevant command, before using the command.

4. When displayed, say **Cancel** to cancel the current voice session.
5. When displayed, say **Help** to get assistance during a voice session.

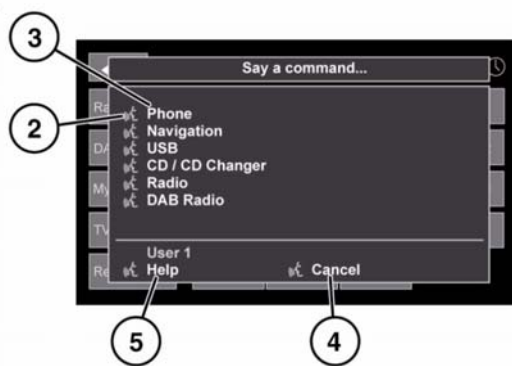

Note: The currently selected user (User 1 or User 2) is identified at the bottom of the command list.

Note: If a listed item is longer than the available space on the menu, ...> will appear. Use the seek controls on the steering wheel to view the entire entry.

VOICE TUTORIAL

To listen to a tutorial detailing the operation of the Voice system:

1. Briefly press the Voice button to start a voice session.
2. Wait for the tone to sound, then say **Voice tutorial**.

Alternatively, the tutorial can be selected using the touch screen, as follows.

1. Select **Setup** from the touch screen Home menu.
2. Select **Voice** from the Setup menu.
3. Select **Operating guide** from the Voice settings menu.
4. Select **Voice tutorial**.

The voice tutorial can be cancelled at any time by touching the on-screen pop-up or by pressing and holding the Voice button.

VOICE TRAINING

This is a feature designed to enable the system to better recognise the vocal characteristics of a user, once the training has been completed.

To carry out Voice training:

1. Select **Setup** from the Home menu.
2. Select **Voice** and from the Setup menu.
3. Select **Voice training** from the Voice settings menu.
4. Select **User 1** or **User 2**, to start the training.
5. Follow the on-screen and audible instructions.

The training session can be cancelled at any time by touching the on-screen pop-up or by pressing and holding the Voice button.

VOICETAGS

Voicetags enable the user to personalise the Voice system so that a single name can be used to call-up a navigation destination, telephone number or radio channel.

To add a Voicetag:

1. Briefly press the Voice button to start a Voice session.
2. Wait for the tone to sound then say **Phone**, **Navigation** or **Radio**.
3. Say **Store voicetag**.

Alternatively, Voicetags can be managed via the touch screen as follows:

1. Select **Setup** from the Home menu.
2. Select **Voice** from the Setup menu.
3. Select **Voicetags** from the Voice settings menu.

4. Select the system which the Voicetag is to activate (**Phone**, **Navigation** or **Radio**).

Follow the on-screen and audible instructions.

NAVIGATION POI VOICE COMMANDS

To request the display of POI (Point Of Interest) identifiers on the navigation display, say **Navigation**, followed by the name of the desired POI category from the following list:

- Petrol station/Petrol.
- Parking/Car park.
- Jaguar Dealer.
- Hospital.
- Golf course.
- Tourist information.
- Restaurant/I'm hungry.
- Shopping centre.
- Hotel.
- Motorway service.
- Town centre.

Icons will appear on the navigation display, indicating the locations of the selected POI. For further information about POIs, see **141**, **CATEGORIES AND SUB-CATEGORIES**.

TELEPHONE SYSTEM OVERVIEW

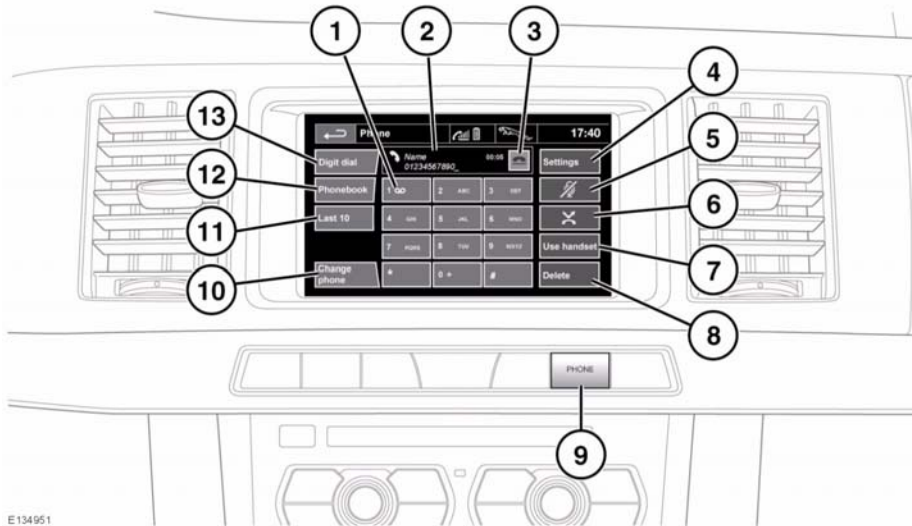

E134951

1. Touch and hold to retrieve your Voice mail.
2. Status display: Displays the name and/or number dialed and call duration.
3. Call Connect/Disconnect icons: Touch to send/accept or end/reject a call.
4. **Settings:** Touch to access Voice mail, Answer options and Phone options.
5. Mute microphone: Touch to initiate Privacy mode. While selected, the caller will not hear you talking.
6. Auto reject: Touch to activate/deactivate. When active, any incoming calls will be rejected or diverted to voice mail (depending on mobile phone settings).
7. **Use handset:** Touch to switch the call to your mobile phone.
8. **Delete:** Touch and release to delete the last entered digit. Touch and hold to delete the whole entered number.
9. **PHONE:** Press for shortcut to the touch screen Phone menu (applicable to Bluetooth® phones only).
10. **Change phone:** Touch to change to another paired phone.
11. **Last 10:** Touch to access the last 10 dialed, received and missed calls.
12. **Phonebook:** Touch to access the downloaded phonebook.
13. **Digit Dial:** Touch to access Digit Dial mode.

BLUETOOTH® INFORMATION



Bluetooth® is the name for short-range radio frequency (RF) technology that allows electronic devices to communicate wirelessly with each other.

The Jaguar Bluetooth® system supports Bluetooth® Hands-Free Profile (HFP), Advanced Audio Distribution Profile (A2DP) and Audio Video Remote Control Profile (AVRCP).

Note: *HFP and A2DP/AVRCP profiles can be connected independently, so a phone can be connected via one, while a media device can be connected via the other, at the same time.*

Before making use of the vehicle's Bluetooth phone system, your Bluetooth phone must be paired and connected to the vehicle system. This is done using one of two methods; via your phone to the vehicle or from the touch screen to your phone. If one of these methods is not successful, try the other option.

Each time the ignition is switched on the system will attempt to connect with the last connected phone.

As mobile phones have a wide range of audio and echo characteristics, it may take a few seconds for the vehicle system to adapt and deliver optimum audio performance. To achieve this, it may be necessary to reduce the in-vehicle volume and ventilation fan speed slightly.

TELEPHONE SAFETY



Switch off your telephone in areas with a high explosion risk. This includes filling stations, fuel storage areas or chemical factories, as well as places where the air contains fuel vapour, chemicals or metal dust.



Always stow your mobile phone securely.



The functioning of cardiac pacemakers or hearing aids may be impaired when the phone is in use. Check with a doctor or manufacturer whether any such devices you or your passengers are using, are sufficiently protected against high-frequency energy.

The Health Industry Manufacturers' Association recommends that a minimum separation of 15 centimetres (six inches) is maintained between a wireless phone antenna and a pacemaker, to avoid potential interference with the pacemaker. These recommendations are consistent with the independent research by, and recommendations of, Wireless Technology Research.

Telephone

TELEPHONE COMPATIBILITY

Please refer to the Ownership section of the Jaguar website at www.jaguar.com, for a list of compatible phones.

Note: *The Bluetooth® equipped phones listed on Jaguar.com, have been tested for compatibility with Jaguar vehicles.*

Performance will vary, based on the phone's software version, battery condition, coverage and your network provider. Phones are warranted by their manufacturer, not Jaguar.

If the mobile phone supports Bluetooth® Hands Free Profile 1.5 (HFP 1.5), additional features will be displayed on the vehicle touch screen, such as battery meter, signal strength and network operator.

PAIRING AND CONNECTING USING THE MOBILE PHONE

Note: *The process of pairing and connecting your phone with the vehicle using the mobile phone will vary depending on the type of mobile phone used.*

1. Switch the ignition on and ensure that the touch screen is active.
2. From the home menu, select **Phone**.
3. A menu will appear. Select **Search new**.
4. Select **Device to vehicle** option.

Note: *The vehicle's Bluetooth® system is discoverable for only 3 minutes.*

5. Using the mobile phone, search for Bluetooth® devices.
On some phones, this is referred to as new paired device. See your phone's operating instructions for further information.

6. When the vehicle's Bluetooth® system is discovered, begin the pairing process using your mobile phone and follow any directions shown on the touch screen. Select **Yes** when prompted, to confirm the pairing.

Either the phone or the vehicle system will ask for a PIN (Personal Identification Number). When prompted, enter a PIN of your choice and select **OK** to confirm.

7. Enter the same PIN into the other device.
8. Once your phone is paired and connected to the system, a confirmation message will be displayed before switching to the Digit Dial screen.

Note: *Some mobile phones require the Bluetooth® pairing to be set as 'authorised' or 'trusted' in order to automatically connect. Please refer to your phone's operating instructions for further information.*

PAIRING AND CONNECTING USING THE TOUCH SCREEN

1. Switch on your mobile phone's Bluetooth® connection. Make sure that your mobile phone is in Bluetooth® discoverable mode, sometimes referred to as find me mode (see your phone's operating instructions for more information).
2. Switch the ignition on and ensure the touch screen is active.
3. From the home menu select **Phone**.
4. A menu will appear. Select **Search new**.
5. Select **Vehicle to device** option.
6. Identify your phone from the displayed list and select the corresponding **Pair and connect** option.

Note: If more than 5 phones are detected, it may be necessary to use the scroll bar to see the entire list.

7. When prompted, enter the PIN code into your phone. See your phone's operating instructions for more information.
8. Once your phone is paired and connected to the system, a confirmation message will be displayed before switching to the Digit Dial screen.

Note: Due to the duration of a Bluetooth® search, it is advised that the timeout to home screen feature is switched off before attempting to search for Bluetooth® devices. This setting can be changed within **Vehicle, Syst settings, Display set, Timeout to home screen**.











CHANGING THE CONNECTED PHONE

Up to 10 mobile phones can be paired with the vehicle in the same way. However, only one can be connected and ready for use as a phone at any one time.

To connect a different paired phone to the vehicle, follow the steps below:

1. From the home menu, select **Phone**.
2. A menu will appear. Select **Change phone**.
3. Identify and select your phone from the displayed list.
4. Once your phone is connected to the system, a confirmation message will be displayed before switching to the Digit Dial screen.

TELEPHONE SYSTEM ICONS

-  Connect. Use to send or accept a call and access last 10 calls list.
-  Disconnect. Use to end or reject a call.
-  No phone connected.
-  Phone signal strength indicator.
-  Phone battery level indicator.
-  Bluetooth. Indicates that a Bluetooth® device is connected.
-  Tick. Indicates that a Bluetooth® device is paired.
-  Voicemail. Press and hold to dial the stored voicemail number.
-  Scroll bar up arrow. Use to scroll up lists of detected phones, calls or phonebook entries.
-  Scroll bar down arrow. Use to scroll down lists of detected phones, calls or phonebook entries.

Telephone

STEERING WHEEL CONTROLS

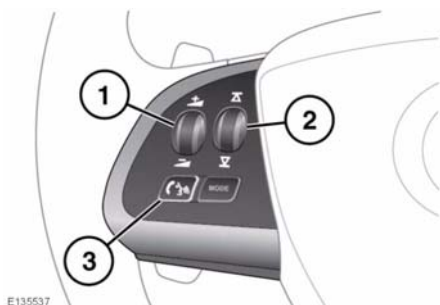

E135537

1. Volume control. Turn to increase/ decrease call volume.
2. Scroll control. Turn to scroll up/ down lists of calls or phonebook entries.
3. Phone/Voice control. Press and release to send, accept or end a call. If Voice control is not fitted, in addition to the above, press and release to access last 10 dialed list; press and hold to access the phonebook search view.

CALL VOLUME

The phone call volume is operated by the audio system's volume control.

If the audio system is in use when a phone call is active, the audio system source is suppressed for the duration of the call.

DIALLING

Once your phone is connected to the vehicle's system, Digit Dial is the default screen in Phone mode.

Using the on-screen keypad, enter the required number and touch the connect icon to send.

Note: When entering a number, you can change the phone number shown on the touch screen using the **Delete** button. A momentary touch erases a single digit, a long touch erases the complete number.

PHONEBOOK

Contacts stored in the memory of a paired phone can be automatically downloaded to the vehicle's phonebook each time the phone is connected to the system. See **130**, **TELEPHONE COMPATIBILITY**.

Certain mobile phones store the phonebook in two different areas, the SIM card and the phone memory. The vehicle system will access only those numbers stored in the phone memory.

To access contacts from the phonebook:

1. From the Phone menu, select **Phonebook**.
2. Using the alpha keys, type the name of the contact you want to search for. Repeated selections of the same key scrolls through the letters displayed on the keys.
3. If the desired contact is shown in the view, they can be dialled by pressing the connect button. Alternatively, select **List** to access the phonebook list view.
4. In the Phonebook list view, touch to call. If a contact has more than one number stored, touch to access the additional numbers.

There are also options to view more contact information, by selecting the corresponding **i** key.

Note: It may be necessary to use the scroll bar to see the entire list.

If your phone supports contact type data, you will be able to see a contact type icon in the vehicle's phonebook directory. These can be seen on the right-hand side of each contact in the directory and will indicate one of the following types:



Default.



Mobile.



Home.



Work.

LAST 10 OPTION

Allows view of the last 10 calls made, received or missed.

Note: *The vehicle will display the list in the order the calls were recorded. If this information is not available, they will be displayed as they are sent from the mobile phone. Some phones may arrange the list in reverse or other order.*

SETTINGS

Depending on vehicle specification, there are up to 3 options in the **Settings** menu:

- The **Voice mail** option allows you to save or edit the number of the voice mail server for your specified network provider.
- **Answer options** allows you to enable/disable the Auto answer feature and, if Voice control is fitted, the Caller announce feature.
- The **Phone options** allow you to set your desired ring tone either to the preset car ring tone, or to the handset ring tone. The Phone options also gives you access to the Phonebook options. See **132, PHONEBOOK.**

Navigation system

THE NAVIGATION SYSTEM

Navigation instruction is by map and turn information displayed on the touch screen and can be complemented by voice guidance if required. The system uses signals from Global Positioning System (GPS) satellites combined with information from vehicle sensors and from data stored on the hard drive, to establish the true vehicle position.

Note: Mapping data loaded on the hard drive is relevant to the market in which the vehicle is first sold and will provide guidance and information only for that area. Your local Dealer will have details of software updates.

Using this combination of data sources the vehicle navigation computer enables you to plan and follow a route map to your desired destination.

The touch screen is used to control navigation via menus, text screens and map displays.

 **Operate the system only when it is safe to do so.**

The requirements of national Road Traffic Regulations always apply.

Observation of traffic signs and local traffic regulations always take priority.

The navigation system serves solely as an aid to navigation. In particular, the navigation system cannot be used as an aid to orientation when visibility is poor.

GPS signals may occasionally be interrupted due to physical barriers such as tunnels and roads under raised highways.

However, direction and speed sensors on the vehicle will minimise any adverse effect on the navigation system. Normal operation will resume once the obstruction has been passed.

Under certain conditions it is possible for the vehicle position shown on screen to be incorrect. This may happen when:

- Driving on a spiral ramp in a building.
- Driving on or beneath elevated roads.
- Two roads are close and parallel.
- The vehicle is transported to another destination.
- After the vehicle is rotated on a turntable.
- After vehicle battery disconnection.

USING THE NAVIGATION SYSTEM

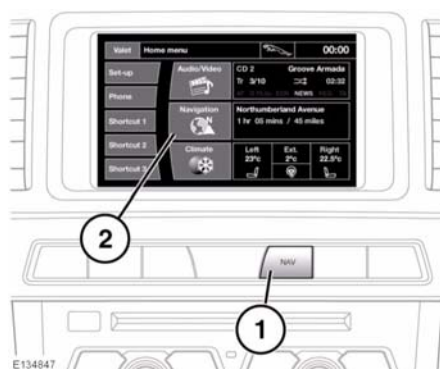

1. **NAV** shortcut button.

2. **Navigation** soft key.

From the **Home menu** touch the **Navigation** soft key. Alternatively, press the **NAV** shortcut button on the facia. A caution screen will be displayed.

If the navigation screen language has not been set, now is the time to set it. Select **Language**, make a selection and confirm it by touching the **OK** soft key. You will be returned to the **CAUTION** screen.

After touching the **Agree** soft key, the touch screen will display the **Nav menu** (which is the navigation system Main menu and covered over two screens) or the screen that was in use when you last switched off the system.

Note: After approximately 12 seconds, the menu soft keys will disappear and display the map information only. This will show current vehicle position. Touch the **Nav menu** soft key to display the Main menu screen.

At this point, the first time user should set up personal preferences in the **Nav set-up** area. These settings are applied whenever navigation is used.

MAIN MENU

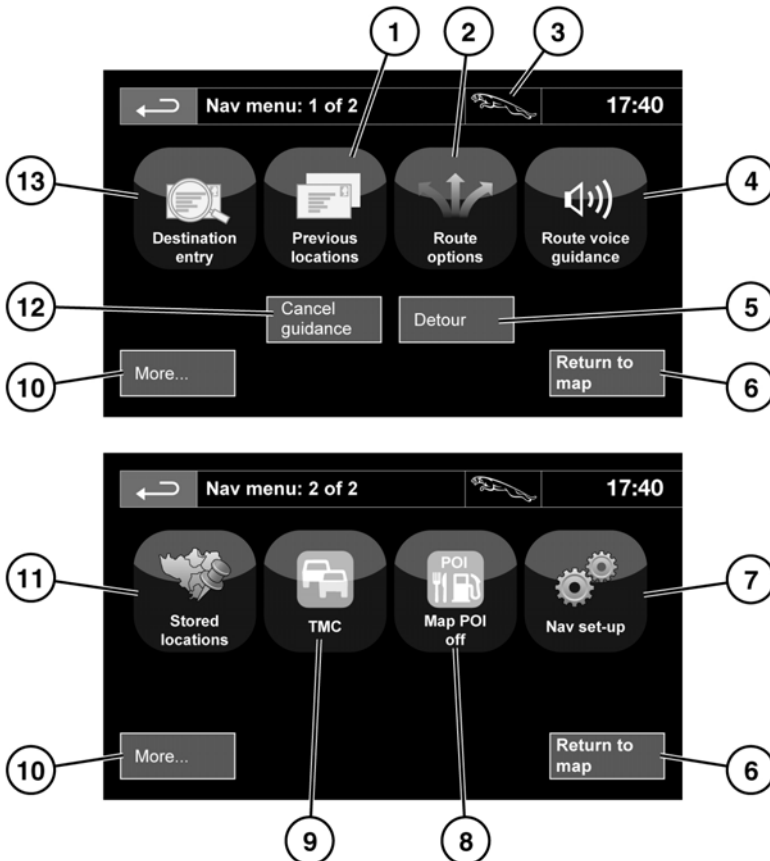

E134953

- 1. Previous locations:** Displays previous destinations entered.
- 2. Route options:** Allows selection of various options for the route.
- 3.** When a destination is set, the Jaguar logo is replaced by a soft key which enables the last voice instruction to be repeated.

Navigation system

4. **Route voice guidance:** Allows the voice guidance messages to be turned off for the current journey. The soft key is highlighted while voice guidance is enabled.
5. **Detour:** Allows a detour from the current route.
6. **Return to map:** Advances to the main map screen.
7. **Nav set-up:** Settings for the navigation system.
8. **Map POI off:** Turns the POI (Point Of Interest) icons on the map on/off.
9. **TMC (Traffic Message Channel):** Not used for entering a destination but, when enabled, will provide data about road conditions and any events that may affect the journey.
10. **More...:** Displays the other Nav menu screen.
11. **Stored locations:** Manages the stored locations.
12. **Stop guidance:** Cancels current route guidance.
13. **Destination entry:** Provides a choice of options for entering a destination.

MAP SPLIT SCREEN

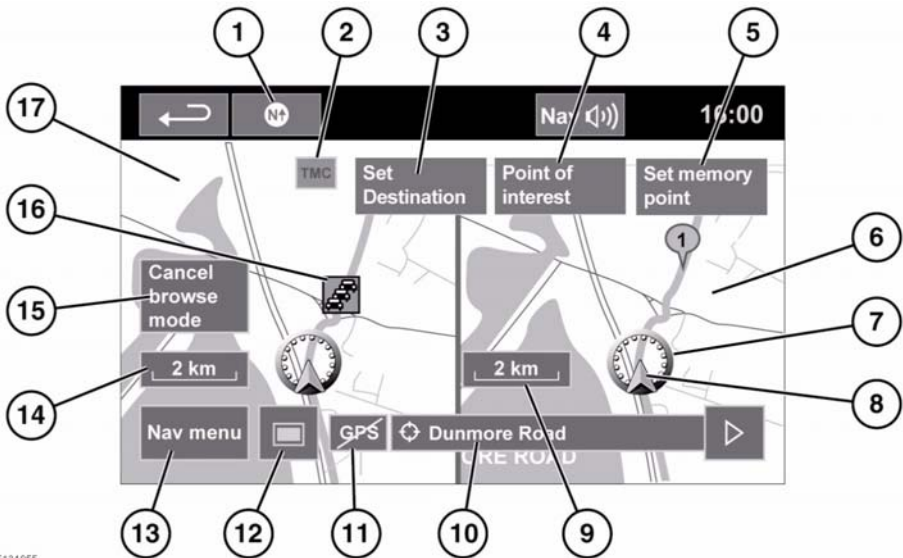

E134955

1. North is up.
2. TMC (Traffic Message Channel) signal. Without a diagonal bar, a signal is being received; with a diagonal bar, a signal is not being received.
3. **Set Destination:** Calculates route from current vehicle position to the scrolled position on map.
4. **Point of interest:** Lists the POI.
5. **Set memory point:** Adds a stored location.
6. Split screen.
7. Current vehicle position.
8. Vehicle direction arrow.
9. Split screen scale/zoom setting.
10. Current street location.
11. GPS signal. Without a diagonal bar, a signal is being received; with a diagonal bar, a signal is not being received.
12. Screen mode selection.
13. **Nav menu:** Opens Navigation menu 1 of 2 screen.
14. Normal screen scale/zoom setting.
15. **Cancel browse mode:** Cancels browse mode on map and displays current vehicle position.
16. TMC event (traffic congestion).
17. Normal screen.

Navigation system

SCREEN MODES

Touch the screen mode selection key to view a series of icons, each depicting a different screen mode (as detailed below). Touch the relevant icon to select the desired screen mode.



Full screen view.



Split screen view. A more detailed view of the local area and road system is displayed on the right.



Shows the next junction in the right half screen.



This view is only available when travelling on a motorway. It displays automatically to show remaining motorway exits along your route.



Shows list of forthcoming junctions and turn directions on the right half screen.

SEARCH AREA

The navigation map database is divided into countries, or areas of countries, called search areas. When setting a route, the destination (or waypoint) entered must be in the currently selected search area.

Before attempting to set a destination or waypoint, set the correct search area as follows:

1. Select **Destination entry** from the main navigation menu.
2. Select page 2 of **Destination entry** then select **Search area**.
3. Scroll through the list and select the 3 letter code that corresponds to the desired destination area.

4. Select **OK**. The destination entry menu is shown and the information window shows the currently selected search area.

SETTING A DESTINATION

After touching **Agree**, the initial map screen is displayed, now select **Nav menu**.

From the Navigation Menu, select **Destination entry**.

Select **Address** from the **Destination** screen and input the town name.

Once sufficient letters have been entered, touch **List** to display all the possible towns.

If necessary, use the scroll arrows to the left of the list to search up or down. Select the town you require.

Now enter the road name. Once sufficient letters have been entered, touch **List** to display all the possible roads.

Select the road you require.

Enter the house number of the address (if known) then touch **OK** to confirm.

If the house number is not known, select **OK** - the mid-point of the road is then used as the destination.

The map screen showing the route settings and destination details is displayed.

START GUIDANCE

After selecting a destination, the system will calculate the route.

There is now a choice to select **3 Routes**, **Change route** or to **Start** navigation guidance.

Touch **3 Routes** to display a choice of three different route options on the map.

The roads on the map are drawn in three different colours to highlight each route.

EcoRoute helps you find the most fuel efficient route available. A display of three leaves indicates the most fuel efficient route.

Select route **1**, **2** or **3** by touching the respective box displayed on the right side of the map.

Touch **Change Route** followed by **Route prefs.** to change the route settings. If a destination is already set, touch **Waypoint** to add a waypoint in the journey if required.

When you have made your selection, if any, touch **Go**.

***Note:** As you approach a junction, in addition to the voice guidance, an inset on the map will display an enlarged view of the junction.*

EASY ROUTE

In **Route options**, **Easy Route** can be turned **On** or **Off**.

When **On** is selected, **Easy Route** changes the calculation parameters of **Route 3** in order to reduce:

- Junctions.
- Turns.
- Turns that cross traffic.
- The priority of minor roads.
- Complex junctions and manoeuvres.

LEARN ROUTE

In **Route options**, **Learn Route** can be turned **On** or **Off**.

When **On** is selected, if you make the same deviation from the proposed route three times, then the system will memorize the deviation and offer that as the normal route from then on. Select **Reset all routes** to delete any learnt routes and return to the default settings.

VOICE GUIDANCE

To turn voice guidance on or off but maintain route guidance, proceed as follows:

1. Touch **Nav menu** on the navigation screen.
2. Touch the **Route voice guidance** soft key. The soft key will be highlighted when voice guidance is enabled.

CANCEL ROUTE GUIDANCE

To cancel route guidance, proceed as follows:

1. Touch **Nav menu** on the navigation screen.
2. Touch the **Cancel guidance** soft key.

QUICK POI SELECTION

Touch the Map screen to display the POI button. Touch the **POI** (Point of interest) button. The screen shows six suggested categories, five of which can be selected as quick points of interest.

***Note:** The POI icons will not be shown if the map zoom level is greater than 1 km (½ mile).*

Select a Quick POI category, or select **More** to see further POIs. Touch **OK** to confirm a selection.

The map screen with the POI icon(s) is displayed. Select the five POIs you wish to see when the Quick POIs are displayed.

Navigation system

RESTORE SYSTEM DEFAULTS

If you have made any changes to the system's default settings, use this menu to restore the original settings.

MEMORY POINTS

From the navigation menu, select **Stored locations**. This enables you to manage destinations such as, place of work, home, favourite restaurant or areas to avoid.

From the **Stored locations** menu you can save up to 400 memory points or add your home address.

Select **Memory Points** to add a stored location.

Touching any of the **Stored locations** submenus allows you to **Add**, **Edit** or **Delete**.

Select **Add** to store a memory point.

MEMORY POINT DETAILS

Touch **Info** to display the details of the selected memory point. The details include Icon, Name, Position and Tel.

The telephone number can be called by touching the telephone button if a telephone is connected.

The memory point details can be edited from the **Stored locations** screen.

POSTCODE

Not all countries have this facility. Enter the postcode of your waypoint or destination from the keypad. The postcode must be entered precisely, including any spaces or punctuation.

When the postcode has been entered touch **OK**.

EMERGENCY

Not all countries have this facility. Touch **Emergency** on the **Destination entry** screen to display a list of local police stations, hospitals or Jaguar Dealerships.

Press **Name** to display the list in alphabetical order or **Distance** to display the list in order of proximity to the current vehicle location.

Touch the name of the facility to set it as a destination or waypoint.

MAP

After selecting map, the local area map is displayed. Drag the circle to the area for your destination or waypoint, zooming in if required.

This location can be stored as a destination or waypoint.

COORDINATES

If you know the coordinates of your destination they can be entered from this screen. The full latitude must be entered first before the longitude coordinates can be entered.

When the coordinates have been entered, touch **OK**.

If the coordinates entered are not contained within the area covered by the available maps, a message will be shown. This can also occur if the incorrect coordinates have been entered.

RECALLING A PREVIOUS DESTINATION

After selecting **Previous** from the menu, the screen shows a list of stored previous destinations. Select your destination by touching the bar. The details will be displayed for confirmation.

Note: *In some markets, list scrolling is not active whilst driving for legislative reasons. Only the items shown at the top of the list can be selected.*

MOTORWAY

After selecting **Motorway** from the menu, enter the motorway name or number, then select an entrance or exit. All of the entrance or exit junctions for the chosen motorway are displayed.

The map showing the selected motorway and the selected exit junction is displayed.

The destination has now been set and the route is calculated.

POINTS OF INTEREST (POI)

After selecting **Points of interest** from the Nav menu, touch **Name** to input the POI name, for example Petrol to display fuel stations on the map, or touch **List** for a list of POIs.

Alternatively, choose **Category** to see all categories of POI and make your selection.

Use the scroll arrows to change pages.

Some POIs are sub-categorised, e.g. selecting **Community** will be further divided into:

- Community Centre.
- Exhibition Centre.
- Hospital.
- Park & Recreation.
- Town Hall

Note: *If entering a POI name results in too many matches being listed, try entering the town name first. If you do not know the name of the POI you want, try selecting a POI category.*

Note: *POI icons can only be displayed up to the 1 km (½ mile) zoom level.*

Once the POI has been selected the route is determined. Touch **Change route.** to change the route settings, or touch **OK** to start the route calculation.

JAGUAR DEALER LOCATIONS

Details of Jaguar Dealers are held on the Navigation System hard drive as a points of interest (POI) category. Certain Dealers may be located in areas that are not fully mapped on the hard drive. If a route is set to one of these Dealers, guidance may only be possible to the nearest town centre; in this case a warning message will be displayed.

Note: *If Jaguar Dealers (or certain other categories, such as airports) are selected, they will be displayed across all search areas.*

ENTRY BY TOWN

If a town name is entered first, the points of interest listed will be restricted to that town.

- From the Input POI Name screen, touch **Town.**
- Enter the town name required.
- Touch **List** to display the list of possible towns.
- Select the town required.

The Input POI screen is displayed again.

- Enter the POI name required.

CATEGORIES AND SUB-CATEGORIES

The POI database is divided into a number of categories. Each main category is further divided into a number of sub-categories.

The first entry in the list of Restaurant sub-categories, is **ALL**. This selects all of the Restaurant sub-categories.

To narrow the search, touch the **Town** button. This will display the alpha keyboard to allow the desired town name to be entered.

When searching the database, only points of interest in the current search area are included, except for the sub-categories marked **All search areas** in the POI category list.

LIST SOFT KEY

The **List** button can be used when the characters entered reduce the possible entries to a small enough number.

You can also select **List** (when active) without entering a POI name. All the relevant points of interest will be displayed, e.g. in a selected town or category.

ALL SOFTKEY

The **All** button shows a list of all POI categories.

LOCAL POI SEARCH

This selects the points of interest in all categories within 32 kilometres (20 miles) of the vehicle.

- Touch the **All Local POIs** button.

RDS-TMC OVERVIEW

RDS-TMC (Radio Data System-Traffic Message Channel) is a feature that announces traffic hold-ups on your route as broadcast by radio stations that transmit TMC information.

Touch the **TMC** button on the Navigation Menu to access the TMC menu.

TMC events ahead on route can be displayed by touching the **Events ahead** soft key. TMC can be set to display on the map for all events, for major events or can be switched off. During route calculation, it can be set to avoid TMC events along the route.

RDS-TMC DISPLAY

When a TMC signal is received the icon in the top left of the screen will appear green. If a TMC signal is not being received, the icon will be shown with a bar through it.

The system will inform the driver of any roadworks, narrow road, contraflow, accidents, slippery road, diversion, information, parking information, congestion or other hazard.

The driver is informed of a traffic event as follows:

- A TMC Event icon shown on the map at the location of the event.
- Text can be displayed showing the details of each occurrence which can be selected either by touching the screen icon or from the traffic information list.
- Dynamic route guidance, which calculates an alternative route when the system receives the traffic event warning affecting the route currently set in the navigation system.
- Traffic event list shows all events sorted by road name/ distance on your selected route in a straight line or along your actual route.

The information regarding the hold-up is maintained and updated even if the vehicle crosses into another country.

RDS-TMC ICONS

Any traffic event (broadcast on TMC) in your area, will be displayed as a warning icon on the map and an alert may be displayed as a message giving the road number(s) and between which junctions the hold-up or event occurs.







This data is stored in the system for up to of 30 minutes.



The colour of the TMC icon changes in order to show the type and priority of a TMC event. The background colour of the icon returns to normal when there is no longer an event or hold-up, or if any re-route instructions are calculated.

The TMC Event icons appear on the navigation map display to indicate the location and nature of a TMC event.

TMC Event icons will appear on the map, even if the event does not occur on your route.

LEVEL 1 TMC EVENT ICONS

-  Incident (Red star)
-  Moving Tailback Ahead (Red arrow)
-  Moving Tailback Both Carriageways (Red double arrow)
-  Slow Traffic Ahead (Yellow arrow)
-  Slow Traffic Both Carriageways (Yellow double arrow)
-  Information (Yellow circle)
-  Incident (Yellow star)

-  Stationary Traffic Ahead (Red arrow pointing on line)
-  Stationary Traffic Both Carriageways (Red double arrow pointing on line)

Note: Single arrow icons indicate that the traffic event affects traffic travelling in the direction of the arrow. Double arrows indicate that both directions are affected.

LEVEL 2 TMC EVENT ICONS

-  Other Hazard (Yellow)
-  Roadworks (Pink)
-  Narrow Road (Pink)
-  Contraflow (Pink)
-  Accidents (Pink)
-  Slippery Road (Yellow)
-  Diversion (Yellow)
-  Parking Information (Grey)
-  Information (Grey)
-  Congestion (Red)

Navigation system

USING TMC

Dynamic route guidance will calculate an alternative route to avoid a traffic event when the system receives an event warning. The system calculates a new route for all sections. However, if any way points are set, the system calculates for the next way point. If the event on route is serious (closed road) or if the new route is shorter than the current one and the current one was not recalculated within the last 5 minutes, then a message to confirm the new route will be displayed. This pop-up message will be displayed for 10 minutes and if the new route is not rejected, then the vehicle will follow the new route.

ORDNANCE SURVEY DATA

Please read this agreement carefully before using the Navigation System.

This is a licence agreement to use the Ordnance Survey (OS) Code-Point data incorporated in the Navigation System. By using this Code-Point data you accept and agree to all the terms and conditions below.

OWNERSHIP

The OS Code-Point data is licensed by Ordnance Survey with permission of Her Majesty's Stationery Office. © Crown Copyright. All rights reserved.

LICENCE GRANT

OS grants you a non-exclusive licence to use your copy of the OS Code-Point data for your personal use solely as part of the Navigation System. You may transfer the licence to a subsequent purchaser of the vehicle with which the Navigation System is supplied, provided that the purchaser agrees to abide by each of the terms of this licence.

LICENCE TERMS

These licence terms are governed by English Law and are subject to the exclusive jurisdiction of the English courts.

LIMITATIONS OF USE

The DATABASE is restricted for use in the specific system for which it was created. Except to the extent explicitly permitted by mandatory applicable laws, you may not extract or re-utilise substantial parts of the contents of the DATABASE, not reproduce, copy, modify, adapt, translate, disassemble, decompile, or reverse engineer any portion of the DATABASE.

LIMITATION OF LIABILITY

The price of the DATABASE does not include any consideration for assumption of risk of consequential, indirect or unlimited direct damages which may arise in connection with your use of the DATABASE.

Accordingly, in no event shall NAVTEQ Corporation or supplier of the navigation system using the DATABASE ('Supplier') be liable for any consequential, special, incidental or indirect damages, including without limitation, loss of revenue, data, or use, incurred by you or any third party arising out of your use of the DATABASE, whether in an action in contract or tort or based on a warranty, even if NAVTEQ Corporation or the Supplier has been advised of the possibility of such damages. In any event, NAVTEQ Corporation's liability for direct damages is limited to the price of your copy of the DATABASE.

THE DISCLAIMER OF WARRANTY AND LIMITATION OF LIABILITY, SET FORTH IN THIS AGREEMENT, DO NOT AFFECT OR PREJUDICE YOUR STATUTORY RIGHTS WHERE YOU HAVE ACQUIRED THE DATABASE OTHERWISE THAN IN THE COURSE OF A BUSINESS. Some states and laws do not allow the exclusion of implied warranties, so the above disclaimer may not apply to you.



The DATABASE reflects reality as existing before you received the DATABASE and it comprises data and information from government and other sources, which may contain errors and omissions. Accordingly, the DATABASE may contain inaccurate or incomplete information due to the passage of time, changing circumstances, and due to the nature of the sources used. The DATABASE does not include or reflect information on - inter alia - neighbourhood safety; law enforcement; emergency assistance; construction work; road or lane closures; vehicle or speed restrictions; road slope or grade; bridge height, weight or other limits; road or traffic conditions; special events; traffic congestion; or travel time.

NAVTEQ CORPORATION

Please read this agreement carefully before using the Navigation System.

This is a licence agreement for your copy of the Navigable Map Database, (the 'DATABASE') originally made by NAVTEQ Corporation), used in the Navigation System. By using this DATABASE you accept and agree to all the terms and conditions below.

OWNERSHIP

The DATABASE and the copyrights and intellectual property or neighbouring rights therein are owned by NAVTEQ Corporation or its licensors.

LICENCE GRANT

NAVTEQ Corporation grants you a non-exclusive licence to use your copy of the DATABASE for your personal use or for use in your business' internal operations. This license does not include the right to grant sub-licenses.

LIMITATIONS OF USE

The DATABASE is restricted for use in the specific system for which it was created. Except to the extent explicitly permitted by mandatory applicable laws, you may not extract or re-utilise substantial parts of the contents of the DATABASE, not reproduce, copy, modify, adapt, translate, disassemble, decompile, or reverse engineer any portion of the DATABASE.

TRANSFER

You may not transfer the DATABASE to third parties, except together with system for which it was created, provided that you do not retain any copy of the DATABASE, and provided that the transferee agrees to all terms and conditions of this agreement.

DISCLAIMER OF WARRANTY

NAVTEQ Corporation does not warrant or make any representations regarding, either express or implied, regarding the use or results of the use of the DATABASE in terms of its correctness, accuracy, reliability, or otherwise and expressly disclaims any implied warranties of quality, performance, merchantability, fitness for a particular purpose or non-infringement.

NAVTEQ Corporation does not warrant that the DATABASE is or will be error-free. No oral or written information or advice provided by NAVTEQ Corporation, your supplier or any other person shall create a warranty.

LIMITATION OF LIABILITY

NAVTEQ Corporation does not warrant or make any representations regarding, either express or implied, regarding the use or results of the use of the DATABASE in terms of its correctness, accuracy, reliability, or otherwise and expressly disclaims any implied warranties of quality, performance, merchantability, fitness for a particular purpose or non-infringement.

NAVTEQ Corporation does not warrant that the DATABASE is or will be error-free. No oral or written information or advice provided by NAVTEQ Corporation, your supplier or any other person shall create a warranty.

GOVERNMENT END USERS

If the DATABASE is for a region of North America and is being acquired by or on behalf of the United States government or any other entity seeking or applying rights similar to those customarily claimed by the United States government, the DATABASE is licensed with 'limited rights'.

Utilization of the DATABASE is subject to the restrictions specified in the 'Rights in Technical Data and Computer Database' clause at DFARS 252.227-7013, or the equivalent clause for non-defence agencies. Manufacturer of the DATABASE of North America is NAVTEQ Corporation, 10400 W. Higgins Road, Suite 400, Rosemont, Illinois 60018, USA.

EUROPEAN DECLARATION OF CONFORMITY



Hereby, DENSO CORPORATION declares that this DN-NS-019 is in compliance with the essential requirements and other relevant provisions of Directive 1999/5/EC.

TYRE REPAIR KIT





-  If you are in any doubt regarding your ability to carry out the instructions, contact your Dealer/Authorised Repairer before attempting the repair.

Your vehicle may not be equipped with a spare tyre. If this is the case, in its place in the rear underfloor storage compartment, you will find a tyre repair kit (except where run-flat tyres are fitted). The tyre repair kit can be used to repair **one** tyre and it is essential that you read the following guide before attempting to repair a tyre.

The tyre repair kit seals most punctures with a maximum diameter of 6 mm (1/4 inch).

Note: The sealant used in the tyre repair kit has a shelf life and the expiry date is shown on the tyre sealant bottle. Ensure that the container is replaced before the expiry date.

TYRE REPAIR KIT SAFETY INFORMATION

-  Some tyre damage may only be partially sealed, or may not seal at all, depending on the amount and type of damage. Any loss of tyre pressure can seriously affect vehicle safety.
-  Do not use the tyre repair kit if the tyre has been damaged by driving while under-inflated.
-  Only use the tyre repair kit to seal damage located within the tyre tread area.
-  Do not exceed 80 km/h (50 mph) when a repaired tyre is fitted to the vehicle.
-  The maximum distance that should be driven when a repaired tyre is fitted, is 200 km (125 miles).

-  When a repaired tyre is fitted, drive with caution and avoid sudden braking or steering manoeuvres.
-  Only use the tyre repair kit for the vehicle with which it was supplied.
-  Do not use the tyre repair kit for any other purpose than tyre repair.
-  Never leave the tyre repair kit unattended when in use.
-  Only use the tyre repair kit within the -30°C to +70°C temperature range.
-  Always keep children and animals at a safe distance from the tyre repair kit when in use.
-  Do not stand directly beside the compressor when it is operating.
-  Check the tyre sidewall prior to inflation. If any cracks, damage or deformities are apparent, do not inflate the tyre.
-  Watch the tyre sidewall during inflation. If any cracks, bumps or similar damage, or deformities appear, switch off the compressor and deflate the tyre.

Tyre repair kit



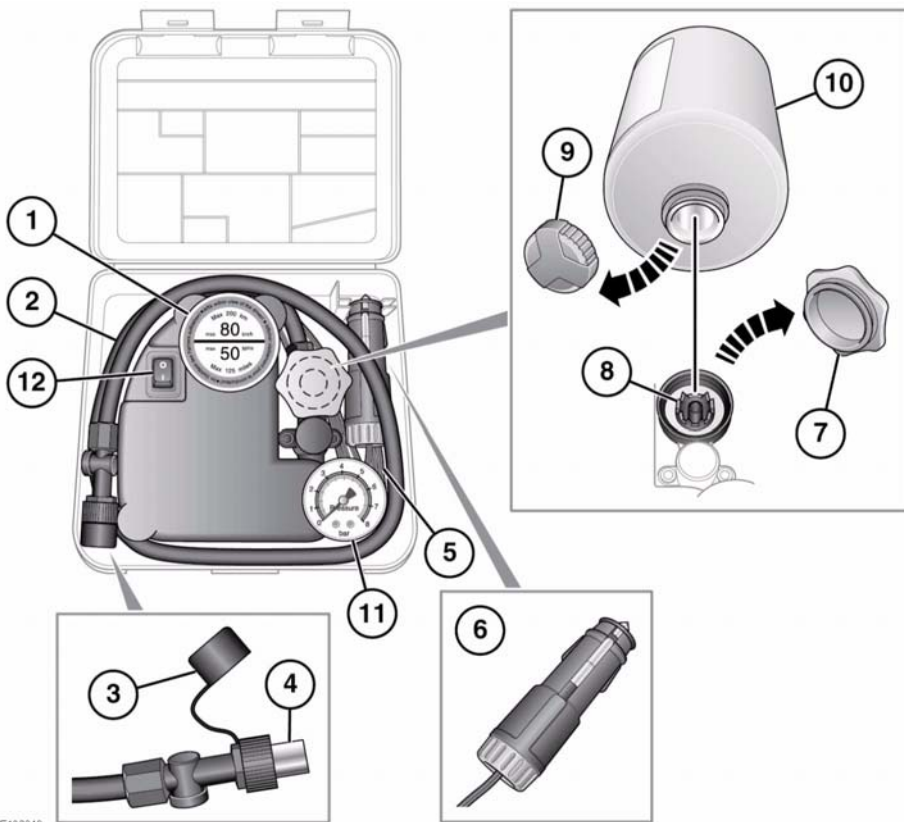



TYRE REPAIR KIT OVERVIEW



E132649

1. Maximum speed label. 80 km/h (50 mph).
2. Tyre inflation hose.
3. Inflation hose protective cap.
4. Inflation hose connector.
5. Compressor power cable.
6. Power cable connector.
7. Sealant bottle receiver cap (orange).
8. Sealant bottle receiver.
9. Sealant bottle cap.
10. Sealant bottle.
11. Tyre pressure gauge.
12. Compressor on/off switch (I = on. 0 = off.).

USING THE TYRE REPAIR KIT

-  Avoid skin contact with the sealant which contains natural rubber latex.
-  If the tyre inflation pressure does not reach 1.8 bar (26 psi, 180 kPa) within seven minutes, the tyre may have suffered excessive damage. A temporary repair will not be possible, and the vehicle should not be driven until the tyre has been replaced.
-  Before attempting a tyre repair, ensure that the vehicle is parked safely, as far away from passing traffic as possible.
-  Ensure that the parking brake is applied and **P** (Park) is selected.
-  Do not attempt to remove foreign objects such as nails, screws, etc. from the tyre.
-  Always run the engine when using the compressor, unless the vehicle is in an enclosed or poorly ventilated space, as this may cause asphyxiation.
-  To prevent overheating, do not operate the compressor continuously for longer than ten minutes.

Note: All vehicle drivers and occupants should be made aware that a temporary repair has been made to a tyre fitted to the vehicle. They should also be made aware of the special driving conditions imposed when using a repaired tyre.

REPAIR PROCEDURE

-  Check the tyre sidewall prior to inflation. If there are any cracks, bumps or similar damage, do not attempt to inflate the tyre. Do not stand directly beside the tyre while the compressor is pumping. Watch the tyre sidewall. If any cracks, bumps or similar damage appear, turn off the compressor and let the air out by means of the pressure relief valve. Do not continue to use the tyre.
1. Open the tyre repair kit and peel off the maximum speed label. Attach the label to the fascia in the driver's field of vision. Take care not to obstruct any of the instruments or warning lights.
 2. Uncoil the compressor power cable and the inflation hose.
 3. Unscrew the orange cap from the sealant bottle receiver and the sealant bottle cap.
 4. Screw the sealant bottle into the receiver (clockwise) until tight.
 - Screwing the bottle onto the receiver will pierce the bottle's seal. Once the receiver has been fitted, a ratchet prevents it from being removed.
 5. Remove the valve cap from the damaged tyre.
 6. Remove the protective cap from the inflation hose and connect the inflation hose to the tyre valve. Ensure that the hose is screwed on firmly.
 7. Ensure that the compressor switch is in the off (0) position.
 8. Insert the power cable connector into the auxiliary power socket.
 9. Unless the vehicle is in an enclosed area, start the engine.

Tyre repair kit

10. Set the compressor switch to the on (I) position.
11. Inflate the tyre to a minimum of 1.9 bar (26 psi) and a maximum of 3.5 bar (51 psi).
 - When pumping the sealant through the tyre valve, the pressure may rise up to 6 bar (87 psi). The pressure will drop again after approximately 30 seconds.
12. During the inflation, switch the compressor off briefly, to check the tyre pressure using the gauge mounted on the compressor.
 - It should not take longer than 7 minutes to inflate the tyre. If, after 7 minutes, the tyre has not yet reached minimum pressure, the tyre should not be used.
13. Once the tyre has been inflated, switch off the compressor. If desired, the engine may be turned off after the compressor has been turned off.
14. Remove the power connector from the auxiliary power socket.
15. Remove the inflation hose from the tyre valve, by unscrewing it as quickly as possible (anticlockwise).
16. Replace the inflation hose protective cap and the tyre valve cap.
17. Ensure that the tyre repair kit (including the bottle and receiver caps) are placed securely in the vehicle. You will need to use the kit to check the tyre pressure after approximately 3 km (2 miles), so ensure they are easily accessible.
18. Immediately drive the vehicle for approximately 3 km (2 miles), to allow the sealant to coat the inner surface of the tyre and form a seal at the puncture.

CHECKING THE TYRE PRESSURE AFTER A REPAIR



When driving the vehicle, if you experience vibrations, abnormal steering, or noises, reduce speed immediately. Drive with extreme caution and reduced speed, to the first safe place to stop the vehicle. Visually examine the tyre and check its pressure. If there are any signs of damage or deformity to the tyre, or the tyre pressure is below 1.3 bar (19 psi), do not continue driving.



Consult a tyre repair centre or your Dealer/Authorised Repairer, for advice concerning the replacement of a tyre after using a tyre repair kit.

1. Drive the vehicle for 3 km (2 miles) then stop in a safe place. Carry out a visual examination of the tyre's condition.
2. Make sure that the sealant container section is in its original position.
3. Screw the inflation hose connector firmly onto the tyre valve.
4. Read the tyre pressure from the gauge.
5. If the pressure of the sealant filled tyre is above 1.3 bar (19 psi) adjust the pressure to the correct value.
6. Ensure that the compressor switch is in the Off (O) position and insert the power cable connector into the auxiliary power socket. If the vehicle is in a well ventilated area, start the engine.
7. Switch the compressor to On (I) and inflate the tyre to the correct pressure.
8. To check the tyre pressure, turn off the compressor then read the pressure from the gauge.



9. When the compressor is off, if the tyre pressure is too high, release the required amount of pressure using the pressure release valve.
10. Once the tyre is inflated to the correct pressure, switch off the compressor and remove the power plug from the auxiliary socket.
 - The use of the tyre repair kit sealant may lead to error prompts and incorrect readings of the Tyre Pressure Monitoring System. Therefore, use the tyre repair kit pressure gauge to check and adjust the damaged tyre's inflation pressure.
11. Unscrew the inflation hose connector from the tyre valve, replace the tyre valve cap and the inflation hose connector protective cap.
12. Ensure that the tyre repair kit is placed securely in the vehicle.
13. Drive to the nearest tyre repair centre or Dealer/Authorised Repairer, for a replacement tyre to be fitted. Ensure that you make the repair centre aware that the tyre repair kit has been used before the tyre is removed.
14. Both the tyre inflation hose, and the sealant container should be replaced once a new tyre has been fitted.





Only sealant containers which are completely empty should be disposed of with normal household waste. Sealant containers which contain some sealant, and the tyre inflation hose, should be disposed of by a tyre specialist or your Dealer/Authorised Repairer, in compliance with local waste disposal regulations.

Fuel and refuelling

SAFETY PRECAUTIONS

-  Avoid exposing the fuel gasses to any potential sources of ignition as the resulting fire and explosion may cause serious injuries and/or death.
-  Switch off the engine when refuelling, as it is both a source of extreme temperatures, and electrical sparks.
-  Switch off any personal electronic devices such as mobile phones, or music players.

PETROL ENGINED VEHICLES

-  Do not use leaded fuels, lead substitutes or fuel additives.
-  Fuel system cleaning agents should not be used, unless approved by Jaguar.

OCTANE RATING



The minimum octane rating for fuel used is 95 RON (Research Octane Number). The vehicle will run on lower ratings, but it may cause pronounced engine knock or pinking. If the pinking is severe it can cause damage to the engine, fuel and emission control systems.

Note: Occasional, light, engine knock experienced while accelerating or climbing hills is acceptable.

Super Green Plus 98 RON unleaded fuel (where available) may be used as an alternative to the standard 95 RON unleaded fuel.

Some countries have only 91 RON fuel available. Vehicles sold in these countries are specially calibrated to use this fuel.

ETHANOL

-  This vehicle is not suitable for use with fuels containing more than 10% ethanol.
-  Do not use E85 fuels (85% ethanol content). Equipment necessary for the use of fuels containing more than 10% ethanol is not fitted to this vehicle. If E85 fuels are used, serious engine and fuel system damage will occur.

Fuels containing up to 10% ethanol (grain alcohol) may be used. Ensure that the fuel has octane ratings no lower than those recommended for unleaded fuel. Most drivers will not notice any operating difference with fuel containing ethanol. If a difference is detected, the use of conventional unleaded fuel should be resumed.

METHANOL

-  Wherever possible avoid using fuel containing methanol.

Some fuels contain methanol (Methyl or wood alcohol). If you use fuels containing methanol the fuels must also contain co-solvents and corrosion inhibitors for methanol. Also, do not use fuels which contain more than 10% methanol even if they contain co-solvents and corrosion inhibitors. Fuel system damage or vehicle performance problems resulting from the use of such fuels is not the responsibility of Jaguar, and may not be covered under the warranty.

METHYL TERTIARY BUTYL ETHER (MTBE)

Unleaded fuel containing an oxygenate known as MTBE can be used provided that the ratio of MTBE to conventional fuel does not exceed 15%. MTBE is an Ether based compound derived from Petroleum, which has been specified by several refiners as the substance to enhance the Octane rating of fuel.

DIESEL ENGINED VEHICLES

⚠ Do not use RME (bio-diesel) except in the case of those proprietary diesel fuels which contain a mix of up to 5%. Jaguar can accept no responsibility for damage caused by using RME in concentrations greater than 5%.

Use only high quality diesel fuel according to EN590 or equivalent.

The quality of diesel fuel is variable, depending on geographic location. Always use premium or the highest quality fuel available in your locality. High quality fuel ensures a longer life for your engine components. Lower grade fuel contains higher levels of sulphur, which is detrimental to engine components. If low quality fuel is used, light coloured smoke may be evident at the exhaust.

Note: *Jaguar vehicles are capable of running with up to a 5% blend of bio-diesel, in accordance with European Standard EN590.*

Prolonged use of additives is not recommended. Do not add paraffin or petrol to diesel fuels.

⚠ If you inadvertently fill your vehicle with petrol instead of diesel, do not attempt to start the engine. Contact your Dealer/ Authorised Repairer immediately.

⚠ Jaguar cars can accept no responsibility for any damage caused by running your vehicle with petrol or vegetable oil in the fuel tank.

SULPHUR CONTENT

⚠ Your vehicle is fitted with a Diesel Particulate Filter (DPF), the maximum Sulphur content must not exceed 0.005%. Using an incorrect fuel will cause serious damage to the DPF.

In some countries diesel may contain higher levels of Sulphur, which could cause damage to the vehicle, if in doubt contact a local Dealer/Authorised Repairer for advice.

RUNNING OUT OF FUEL

⚠ Avoid running out of fuel!
If the vehicle does run out of fuel, a minimum of 4 litres (0.9 gallons) will be required to restart the engine. The vehicle should be left with the ignition on for 5 minutes after refuelling before attempting to restart the engine.

Note: *If the vehicle does run out of fuel, seeking qualified assistance is advisable.*

WATER IN FUEL

⚠ If the warning **WATER IN FUEL** is displayed in the message centre, an excessive amount of water has collected in the fuel filter bowl. Seek assistance from a Jaguar Dealer/ Authorised Repairer to have the filter drained as soon as possible.

Fuel and refuelling

DIESEL ENGINES

Vehicles with diesel engines are equipped with a system to prevent the fuel tank from emptying completely. When the fuel reaches a minimum level, the system will activate a reduced power mode (i.e. the engine will not run properly). This will be followed by the engine stopping in approximately 1.6 km (1 mile).

This feature prevents the fuel system from running dry, which could cause damage to the vehicle. If the gauge indicates low fuel or the warning indicator illuminates, the fuel tank should be refuelled as soon as possible at the next filling station, with at least 4 litres (0.9 gallons) of fuel.

If the system protection function has activated, the vehicle must firstly be refuelled, then restarted using the following procedure:

1. With the brake pedal pressed, press and hold the engine START/STOP button and crank the engine for five seconds.
2. Release the START/STOP button.
3. With the brake pedal pressed, press and release the START/STOP button to crank the engine. The engine should start within approximately five seconds.

Note: *If the engine does not start, pause for ten seconds with the ignition in convenience mode, before repeating the procedure from the beginning.*

-  Do not crank the engine for longer than 30 seconds continuously.

FUEL FILLER FLAP

-  **Take note of all warnings and instruction given on the label affixed to the inside of the filler flap.**

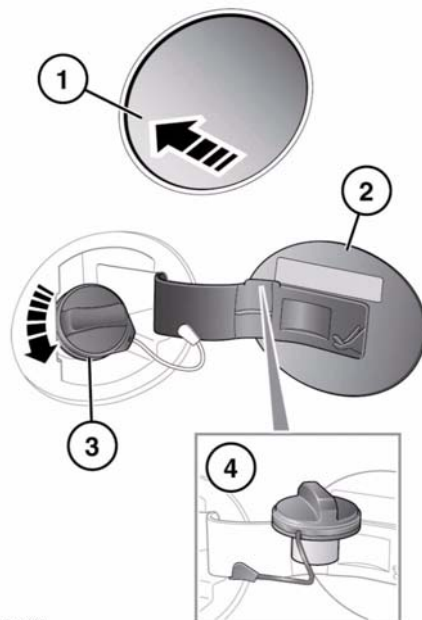

E 134 357

The vehicle must be unlocked using the Smart Key, before the filler flap can be opened.

1. Press and release the rear of the flap (in the area indicated) to unlatch.
2. Pull the flap open. The label on the inside of the flap indicates the correct fuel for the vehicle.
3. Twist the cap anticlockwise to undo.
4. Stow the cap on the lip provided on the top of the hinge arm, as shown.

When replacing the cap, turn it clockwise until the ratchet clicks. Failure to do so may cause the Engine malfunction warning lamp to illuminate. If the warning lamp illuminates, ensure the cap is fitted properly.

To close the filler flap, push the flap until latched closed.

Note: The filler flap will only be locked closed when the vehicle is centrally locked.

FUEL FILLER

 **When refuelling ensure that all windows, doors, and sunroof are fully closed, particularly if young children or animals are in the vehicle.**

 **Do not attempt to fill the tank to its maximum capacity. If the vehicle is to be parked on a slope, in direct sunlight or high ambient temperature, expansion of the fuel could cause spillage.**

 Check the fuel pump information carefully, to ensure that you are putting the correct fuel into the vehicle.

 If the vehicle is filled with incorrect fuel, it is essential that you seek qualified assistance before you start the engine.

Fuel station pumps are equipped with automatic cut-off sensing, to avoid fuel spillage. Fill the tank until the filler nozzle automatically cuts off the supply. Do not attempt to fill the tank beyond this point.

Note: Filling station pumps used for diesel commercial vehicles deliver fuel at a higher rate than normal. The higher fill rate can cause premature cut-off and may cause fuel spillage. Therefore, it is recommended that only standard light vehicle pumps are used.

DIESEL MISFUELLING PROTECTION DEVICE

 **When the misfuelling device is activated it may cause fuel to be discharged from the filler neck.**

If the narrow filler nozzle fitted to pumps delivering unleaded petrol is fully inserted into the filler neck the misfuel protection device will activate.

Note: The spout on some fuel cans and older fuel pumps may trigger the misfuelling device.

When activated, the yellow protection device will be visible inside the filler neck. It will prevent fuel flow into the tank. Before fuelling can continue with the correct fuel the device will need to be reset.

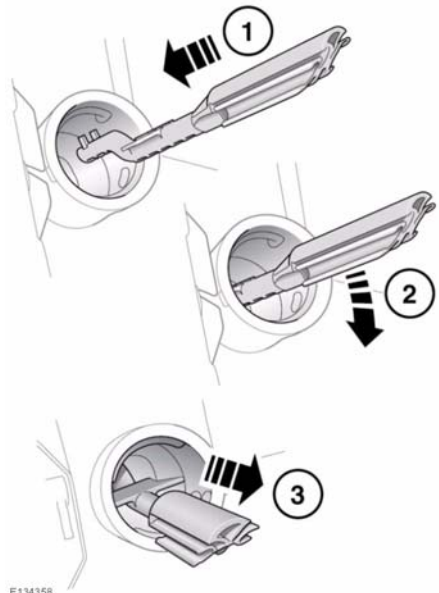

E134358

The reset tool is stored in the luggage compartment clipped onto the battery retaining bar.

Fuel and refuelling

To reset the misfuelling device:-

1. Insert the reset tool with teeth uppermost, as far as it will go into the filler neck.
2. Locate the teeth by pushing down the top of the reset tool.
3. With the top of the tool pressed down and the teeth engaged, slowly pull the tool out of the filler neck to reset the device.



Do not twist the device, once the teeth have engaged.

Note: *The yellow part of the protection device should no longer be visible in the filler neck.*

Replace the reset tool in position on the battery restraining bar.

FUEL TANK CAPACITY

Avoid the risk of running out of fuel and never intentionally drive the vehicle when the fuel gauge indicates that the tank is empty. When refuelling your vehicle after the fuel gauge reads empty, you may not be able to add the fuel quantity shown below, as there will be a small reserve remaining in the tank.

Total tank capacity (usable):	
Petrol engines	69.5 litres (15.3 gallons)
Diesel engines	68.1 litres (15 gallons)
Fill capacity (when fuel gauge reads empty)	64 litres (14.1 gallons)
Reserve capacity (when fuel gauge reads empty)	5.5 litres (1.2 gallons)

FUEL SPECIFICATION

Petrol	Diesel
95-98 RON	EN 590

FUEL CONSUMPTION

The fuel consumption figures shown below have been calculated using a standard testing procedure (the new EC test procedure from Directive 99/100/EC), and produced in accordance with The Passenger Car Fuel Consumption (Amendment) Order 1996.

Under normal use, a vehicle's actual fuel consumption figures may differ from those achieved through the test procedure, depending on driving technique, road and traffic conditions, environmental factors, vehicle load and condition.

Variant	Urban l/100 km (mpg)	Extra-urban l/100 km (mpg)	Combined l/100 km (mpg)	CO ₂ emissions g/km
2.2 I4 Diesel	6.6 (42.8)	4.8 (58.9)	5.4 (52.3)	149
3.0 V6 Diesel	8.7 (32.5)	5.0 (56.5)	6.3 (44.8)	169
3.0 V6 Petrol	15.8 (17.8)	7.5 (37.8)	10.5 (26.8)	249
5.0 V8 Petrol - Normally aspirated	17.3 (16.3)	7.8 (36.4)	11.1 (25.4)	264
5.0 V8 Petrol - Supercharged	18.7 (15.1)	8.7 (32.4)	12.5 (22.5)	292

URBAN CYCLE

The urban test cycle is carried out from a cold start and consists of a series of accelerations, decelerations and periods of steady speed driving and engine idling. The maximum speed attained during the test is 50 km/h (30 mph) with an average speed of 19 km/h (12 mph).

EXTRA-URBAN CYCLE

The extra-urban test cycle is carried out immediately after the urban test. Approximately half of the test comprises steady-speed driving, while the remainder consists of a series of accelerations, decelerations and engine idling. The maximum test speed is 120 km/h (75 mph) and the average speed 63 km/h (39 mph). The test is carried out over a distance of 7 km (4.3 miles).

COMBINED

The combined figure is an average of the urban and extra-urban test cycle results, which has been weighted to take account of the different distances covered during the two tests.

For additional information on fuel consumption figures and exhaust emissions, visit the Vehicle Certification Agency (VCA) website at <http://www.vcacarfueldata.org.uk/>.



DISABILITY MODIFICATIONS

Occupants with disabilities which may require modification of the vehicle, must contact a Dealer/Authorised Repairer before any modifications are made.

PARTS AND ACCESSORIES



Do not fit non-approved parts and accessories or carry out non-approved alterations or conversions.



Your vehicle is not designed for use with a roof rack. Do not fit a roof rack to the vehicle, as damage may result.

AIRBAG SYSTEM



The components that make up the airbag system are sensitive to electrical or physical interference, either of which could easily damage the system and cause inadvertent operation or a malfunction of the airbag module.

To prevent malfunction of the airbag system always consult your Dealer/Authorised Repairer before fitting any of the following:

- Electronic equipment such as a mobile phone, two-way radio or in-car entertainment system.
- Accessories attached to the front of the vehicle.
- Any modification to the front of the vehicle.
- Any modification involving the removal or repair of any wiring or component in the vicinity of any of the airbag system components, including the steering wheel, steering column, instrument or fascia panels.
- Any modification to the fascia panels or steering wheel.

ANTI-THEFT SYSTEM



No modifications or additions should be made to the anti-theft system. Such changes could cause the system to malfunction.

OWNER MAINTENANCE



Any significant or sudden drop in fluid levels, or uneven tyre wear, should be reported to a qualified technician without delay.

In addition to the routine services and inspections, a number of simple checks must be carried out more frequently. These checks can be carried out by the owner and advice is given on the pages that follow.

DAILY CHECKS

- Operation of lamps, horn, direction indicators, wipers, washers and warning indicators.
- Operation of seat belts and brakes.
- Look for fluid deposits underneath the vehicle that might indicate a leak. Condensation drips from the air conditioning are normal.

WEEKLY CHECKS

- Engine oil level.
- Engine coolant level.
- Brake fluid level.
- Power steering fluid level.
- Screen washer fluid level.
- Tyre pressures and condition.
- Operate air conditioning.

Note: *The engine oil level should be checked more frequently if the vehicle is driven for prolonged periods at high speeds.*

DIESEL PARTICULATE FILTER (DPF)

Diesel vehicles equipped with a particle filter have more efficient emission control. The particles in the exhaust gases are collected in the filter during normal driving.

When a DPF message is displayed, the filter requires a regeneration cycle to clean itself. This requires the engine to have reached normal operating temperature. Regeneration takes place automatically at an interval of approximately 300-900 km (190-560 miles) depending on driving conditions. Regeneration normally takes 10-20 minutes and is automatically requested by the engine control module if the vehicle is driven steadily at vehicle speeds between 40mph to 70mph. It is possible that the regeneration process will occur at lower vehicle speeds, but the events may take a little longer at a 50 km/h (30mph) average speed.

DRIVING SHORT DISTANCES OR IN COLD WEATHER

If the vehicle is frequently driven short distances or in cold weather conditions then the engine may not reach normal operating temperature. This means that regeneration of the diesel particle filter does not take place and the filter is not efficiently cleaned. When the filter reaches a condition when a filter regeneration is appropriate and the current drive style is not appropriate, a warning triangle on the instrument panel illuminates, and the message **DPF Full. See manual** is displayed on the instrument panel. This is not indicating a fault condition with the vehicle and no dealership support should be required. Start regeneration of the filter by driving the vehicle, preferably on a main road or motorway. The vehicle should then be driven for approximately 20 minutes or more.

When regeneration is complete the warning text is cleared automatically.

Note: *A small increase in fuel consumption may be noticed temporarily during regeneration.*

ARDUOUS DRIVING CONDITIONS

When a vehicle is operated in severe or arduous conditions, more frequent attention must be paid to servicing requirements. Refer to your Service Portfolio for details or contact your Dealer/Authorised Repairer for advice.

SAFETY IN THE GARAGE



If the vehicle has been driven recently, do not touch exhaust and cooling system components until the engine has cooled.



Never leave the engine running in an unventilated area.



Do not work beneath the vehicle with a jack as the only means of support.



Keep your hands and clothing away from drive belts, pulleys and fans. Some fans may continue to operate after the engine has stopped.



Remove metal wrist bands and jewellery, before working in the engine compartment.





Do not touch electrical leads or components while the engine is running, or with the starter switch turned on.



Do not allow tools or metal parts of the vehicle to make contact with the battery leads or terminals.

Maintenance

FUEL SYSTEM

-  Under no circumstances should any part of the fuel system be dismantled or replaced by anyone other than a suitably qualified vehicle technician.
-  Ensure sparks and naked lights are kept away from the engine compartment.
-  Wear protective clothing, including, where practicable, gloves made from an impervious material.

USED ENGINE OIL

Prolonged contact with engine oil may cause serious skin disorders, including dermatitis and cancer of the skin. Always wash thoroughly after contact.

OPENING THE BONNET

-  Do not attempt to open the bonnet if the pedestrian protection system has deployed.



E134361

1. Pull the bonnet release handle located in the left-hand front footwell.
2. Lift the bonnet safety catch lever located below the centre point of the bonnet, and raise the bonnet.

CLOSING THE BONNET

-  Do not drive with the bonnet retained by the safety catch alone.
1. Lower the bonnet until the safety catch engages. Using both hands, press the bonnet down until the catches click.
 2. Check that both catches are fully engaged by attempting to lift both sides of the front edge of the bonnet. This should be free from all movement.

ENGINE COMPARTMENT OVERVIEW

Diesel engines

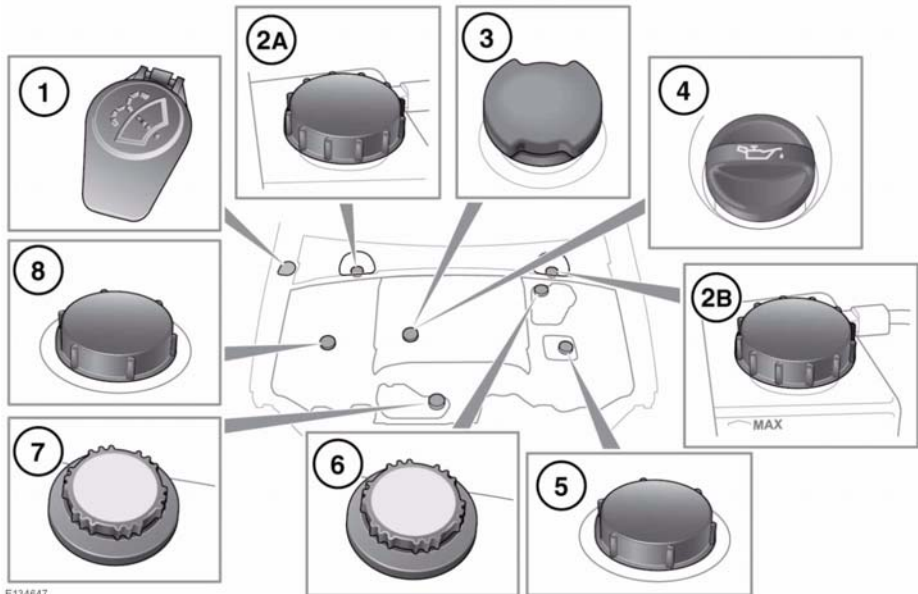

E134647

1. Washer fluid.
2. Brake fluid:
 - A. Right-hand drive vehicles.
 - B. Left-hand drive vehicles.
3. Engine oil (V6 engines).
4. Engine oil (I4 engines).
5. Power steering (I4 engines).
6. Coolant (I4 engines).
7. Coolant (V6 engines).
8. Power steering (V6 engines).



Do not drive the vehicle if there is a possibility that leaked fluid will come into contact with a hot surface, such as the exhaust.

Petrol engines

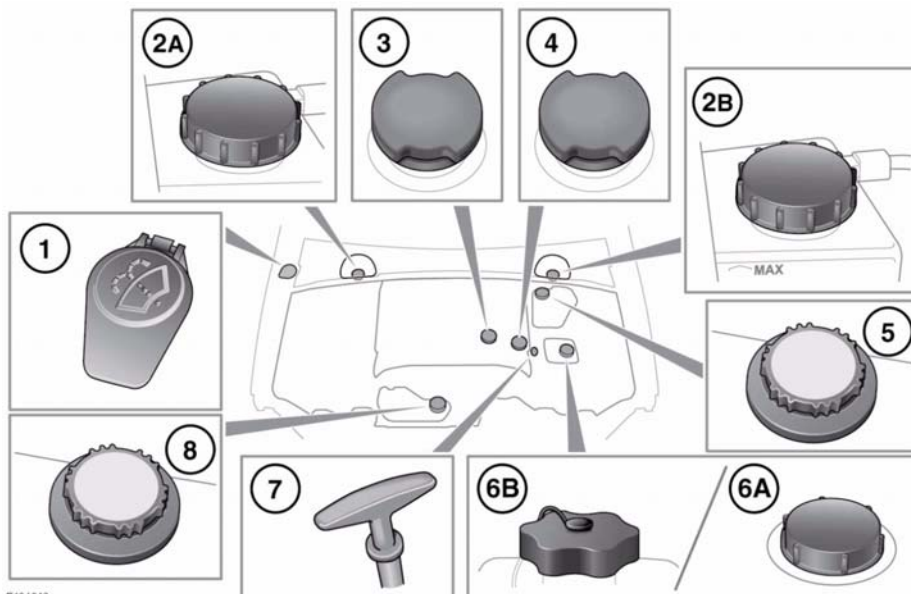

E134648

1. Washer fluid.
2. Brake fluid:
 - A. Right-hand drive vehicles.
 - B. Left-hand drive vehicles.
3. Engine oil (V6 engines).
4. Engine oil (V8 engines).
5. Coolant (V8 engines).
6. Power steering.
 - A. V8 engines.
 - B. V6 engines.
7. Engine oil dipstick (V6 engines).
8. Coolant (V6 engines).



Do not drive the vehicle if there is a possibility that leaked fluid will come into contact with a hot surface, such as the exhaust.

UNBLOCKING WASHER JETS



Do not operate the washer jets during adjustment. Windscreen washer fluid may cause irritation to the eyes and skin. Always read and observe the washer fluid manufacturers instructions.

If a washer jet becomes blocked, use a thin strand of wire to unblock the jet by inserting the wire into the jet. Ensure that the wire is completely removed after unblocking.

LAMP FAILURE

Headlamp unit:

- ⚠ **The headlamps are Xenon High Illumination Density (HID) units. Replacement or maintenance of Xenon lamps should only be carried out by qualified personnel.**
- ⚠ **High voltage is required to ignite the Xenon lamps.**
- ⚠ **Xenon lamp units operate at a very high temperature. Ensure that the lamp units have cooled before attempting to touch them.**
- ⚠ **Used Xenon lamp units contain mercury which is hazardous and can be injurious to health.**
- ⓘ All other lamps within the headlamp unit are LEDs and should only be replaced by a Dealer/Authorised Repairer.

Correct disposal of the Xenon lamp unit should be referred to your Jaguar Dealer/Authorised Repairer or your local authority.

Side, repeater and rear lamps:

- ⓘ These lamps are LED units and should only be replaced by a Dealer/Authorised Repairer.

LICENSE PLATE LAMP BULB REPLACEMENT

- ⓘ Always replace bulbs with the correct type and specification. If you are in any doubt contact your Dealer/Authorised Repairer for advice.
- ⓘ Before attempting to replace a bulb, ensure that both the affected lamp and the ignition are turned off. Otherwise, damage to the vehicle's electrical system may occur.

License plate lamps each contain a 5 Watt W5W bulb. To replace a bulb:

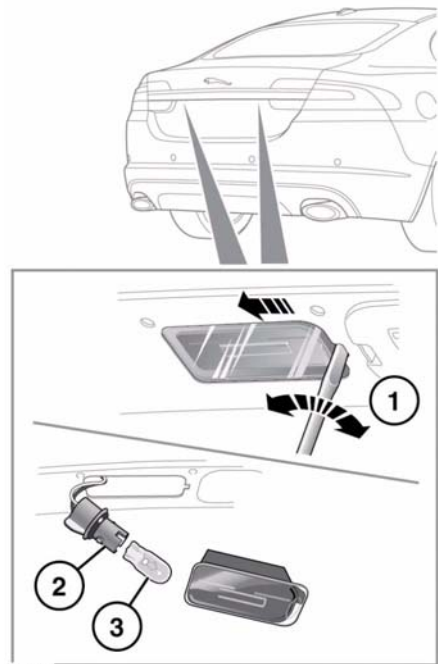

E135415

1. Insert a small flat-bladed screwdriver into the indent as shown and carefully lever out the side of the lamp unit and remove.
2. Twist the bulb holder 90 degrees anticlockwise to access the bulb.
3. Pull to remove the bulb from the holder.

SUNROOF RESET

If the battery is disconnected, or the power supply is interrupted, whilst the sunroof is partially open it will need to be reset.

Once the power supply is restored, reset the sunroof as follows:

1. Switch the ignition on.
2. Press the front of the sunroof switch, so that the sunroof is in the tilt position, then release the switch.
3. Press the front of the sunroof switch, and hold for 30 seconds.
4. After 30 seconds the sunroof will begin to move. Keep the front of the switch pressed until the sunroof has fully opened, then closed.
5. Once the open/close cycle has completed and the sunroof has stopped moving, release the switch.

The sunroof can now be operated as normal.

WINDOW RESET

The windows will need to be reset if the battery is disconnected, becomes discharged or power supply is interrupted.

Once the power supply is restored, reset the windows as follows:

1. Close the window fully.
2. Release the switch, then lift it to the close position and hold for 2 seconds.
3. Open the window fully.
4. Release the switch, then push it to the open position and hold for 2 seconds.
5. Lift and release the switch to operate the one-touch function.
6. Repeat the procedure on each window.

WARNING TRIANGLE

The warning triangle is located in the luggage compartment, attached to an anchor point.

FIRST AID KIT

If supplied, the first aid kit is strapped to the side of the luggage compartment.

FIRE EXTINGUISHER

If supplied, the fire extinguisher will be located either in the luggage compartment, or mounted to the front passenger seat.

REPAIRING MINOR PAINT DAMAGE

Regularly inspect the paintwork for damage. Any stone chips, fractures, or deep scratches, in the paint/bodywork should be repaired promptly. Bare metal will corrode quickly, and if left untreated can result in expensive repairs.

CLEANING THE ALLOY WHEELS



Only use approved wheel cleaning products.

CLEANING THE EXTERIOR



Some high pressure cleaning systems are sufficiently powerful to penetrate door and window seals, and damage trim and door locks. Never aim the water jet directly at the engine air intake, heater air intakes, body seals or at any components which may be damaged.



Never use cleaning products which are not approved for use on vehicles.



Following cleaning of the vehicle exterior (particularly with a pressure washer), it is recommended that the vehicle is taken for a short drive in order to dry out the brakes.

WASHING THE VEHICLE PAINTWORK

- ⚠ Substances which are corrosive can damage the vehicle's paintwork and should be removed to prevent damage.

USING AN AUTOMATIC WASH

- ⚠ Commercially operated automatic car washes, jet washes and power-operated mops, are not recommended.

UNDER BONNET CLEANING

- ⚠ Do not use a high pressure washer or steam cleaner in the engine compartment.
- ⚠ Ensure that the brake fluid reservoir is kept dry at all times. Only use a clean, dry cloth to clean the brake fluid cap and reservoir.

CLEANING GLASS SURFACES

Clean the rear window with a soft cloth to avoid damaging the heating element. Do not scrape the glass or use any abrasive cleaning fluid.

Mirror glass is particularly susceptible to damage. Wash with soapy water. Do not use abrasive cleaning compounds or metal scrapers to remove ice.

To avoid damaging the protecting coating, only clean the interior side of the sunroof glass with a soft cloth. Do not scrape the glass or use abrasive cleaning fluids.

CLEANING THE REAR SCREEN

To avoid damaging the heating elements when cleaning the inside of the rear screen, use only a soft damp cloth or chamois leather. Do not use solvents or sharp objects to clean the glass.

CLEANING THE SUNROOF WIND DEFLECTOR

A mild solution of soap and water, or car shampoo should be used to clean the wind deflector net periodically. Support the underside of the net with a soft cloth, and gently scrub the net using a soft bristled brush.

REMOVING GREASE AND TAR

Remove grease or tar with Jaguar Tar Remover or methylated spirit (alcohol). White spirit is also effective, but must not be applied to rubber, particularly the windscreen wiper blades.

- ⚠ Ensure that after using methylated or white spirit, the area is washed immediately with soapy water, to remove all traces of spirit.

POLISHING

- ⚠ Chrome polish, or other abrasive cleaners, must not be used on the vehicle's brightwork.

It is recommended that the vehicle is polished regularly using Jaguar polish and a polishing cloth.

CLEANING THE INTERIOR

- ⚠ The steering wheel centre pad and other areas containing airbags should only be cleaned sparingly with a damp cloth, warm water and a non-detergent soap.

Maintenance

LEATHER

To prevent ingrained dirt and staining, inspect the seat upholstery regularly and clean every one to two months, as follows:

- Wipe off fine dust from the seat surfaces using a clean, damp, non-coloured cloth. Change frequently to a clean area of cloth, to avoid abrasive action on the leather surface. Avoid over-wetting.
- If this is not sufficient, use a cloth which has been dampened with warm soapy water and then wrung out. Use only mild non-caustic soap.
- Use Jaguar Leather Cleaner for heavily soiled areas. Dry off and rub with a clean soft cloth, changing surfaces regularly.

Use Jaguar Leather Cleaner several times a year to maintain its appearance and suppleness. The cleaner will nourish and moisturise and help to improve the surface protective film against dust and substances.

- Do not use solvents. Do not use detergents, furniture polish or household cleaners. While these products may initially give impressive results, their use will lead to rapid deterioration of the leather and will invalidate the warranty. Jaguar recommend a basic set of products that have been specially selected for the type of leather in your vehicle.
- Dark clothing may stain leather seats just like other upholstery products.
- Sharp objects such as belts, zip fasteners, rivets, etc., can leave permanent scratches and scratch marks on the leather surface.
- Unless spillages such as tea, coffee or ink are washed away immediately, permanent staining may have to be accepted.

If a valet service is used, ensure that the specialist concerned is aware of, and follows, these instructions precisely.

CLEANING FABRIC UPHOLSTERY

- ! Never use soap, ammonia, bleach or other cleaners intended for use on hard surfaces.
- ! Do not use upholstery cleaner on electrical equipment such as facia switches.
- ! When cleaning around electrical equipment such as switches, ensure that fluids do not leak into any gaps around the components or between panels or trim.

Use Jaguar Upholstery Cleaner, following the instructions. Avoid over-wetting.

REMOVING STAINS

Most stains on woollen fabric can be removed if treatment is carried out immediately, before the stain has a chance to dry-in.

Most stains can be treated with one of three cleaning fluids: Jaguar Upholstery Cleaner, dry cleaning fluid or clean water. Follow the instructions on the package.

INSTRUMENT PANEL, CLOCK AND AUDIO EQUIPMENT

Only use a soft dry cloth to clean the instrument panel, clock and audio equipment. Do not use cleaning fluids or sprays.

TOUCH SCREEN

- ! Do not use abrasive cleaners on the touch screen. For approved cleaning products, contact your Dealer/ Authorised Repairer.

CARPETS AND MATS

Marks or stains can be removed by gentle scrubbing with a weak solution of soap and warm water.

For more stubborn stains a commercially available carpet cleaner should be used.

SEAT BELTS



Do not allow any water, cleaning products, or fabric from cloths to enter the seat belt mechanism. Any substance which enters the mechanism may affect the performance of the seat belt in an impact.

Extend the seat belts fully, then use warm water and a non-detergent soap to clean. Allow the seat belts to dry naturally whilst fully extended and do not allow the belts to retract until fully dry.

***Note:** Whilst cleaning the seat belt, take the opportunity to examine the webbing for damage and wear. Any wear or damage should be reported to, and rectified by, a Dealer/ Authorised Repairer.*

AIRBAG MODULE COVERS



Airbag covers should only be cleaned using a slightly dampened cloth, and a small amount of upholstery cleaner.



Any substance which enters the mechanism, can prevent correct deployment of an airbag during an impact.

Fluid level checks

CHECKING THE ENGINE OIL LEVEL

- ❗ Check the engine oil weekly. If any significant or sudden drop in oil level is noted, seek qualified assistance.
- ❗ If the message **ENGINE OIL PRESSURE LOW** is displayed, stop the engine as soon as it is safe to do so and seek qualified assistance. Do not start the engine until the cause has been rectified.

Prior to checking the oil level ensure that the vehicle is on level ground.

All except V6 petrol engines

Ensure that:

- The engine oil has reached working temperature (oil is hot).
- The engine has been switched off for ten minutes, as the system will not give an accurate reading until the oil level has stabilised.

The oil level can then be checked as follows:

1. Switch on the ignition (do not start the engine).
2. Ensure Park (P) is selected.
3. Press the trip button (on the end of the lighting control stalk) repeatedly until the oil can icon, along with the current oil level status and topping-up advice is displayed in the message centre, as follows.

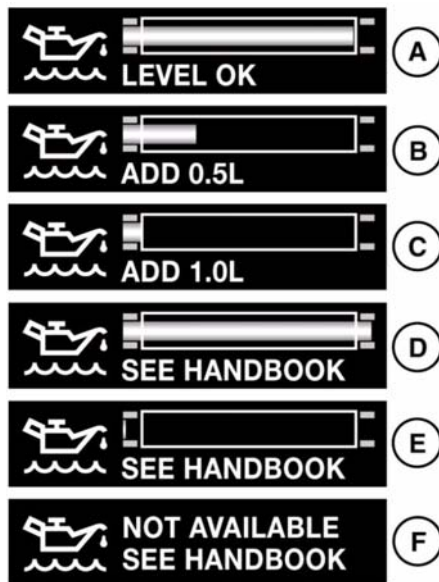

E134345

- A. Oil level at recommended level. No top-up required.
- B. Add 0.5 litres (0.9 pints) of oil.
- C. Add 1 litre (1.8 pints) of oil.
- D. Oil level above maximum for safe operation. Do not drive the vehicle. Seek qualified assistance.
- E. Oil level below minimum for safe operation. Add 1.5 litres (2.6 pints) of oil, then recheck the level.
- F. Oil level stabilising, oil level not available. Wait 10 minutes, then recheck the oil level display.

If this display is accompanied by the warning message **ENGINE OIL LEVEL MONITOR SYSTEM FAULT**, seek qualified assistance.

V6 petrol engines

Note: If it is necessary to check the oil level when the engine is hot, switch off the engine and let stand for five minutes to allow the oil to drain into the sump. Do not start the engine.

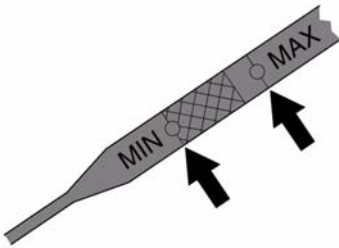

E135350

1. Withdraw the dipstick and wipe the blade clean with a lint free cloth.
2. Fully re-insert the dipstick and withdraw again to check the oil level. Never allow the oil level to fall below the lower mark or notch on the dipstick.

As a general guide, if the level on the dipstick:

- Is nearer to the upper mark or notch than the lower, add no oil.
- Is nearer to the lower mark or notch than the upper, add half a litre (one pint) of oil.
- Is below the lower mark or notch, add one litre (two pints) of oil and re-check the level after a further five minutes.

ENGINE OIL SPECIFICATION

- ❗ Low quality or obsolete oils do not provide the protection required by modern, high performance engines.
- ❗ Failure to use an oil that meets the required specification could cause excessive engine wear, a build up of sludge and deposits and increased pollution. It could also lead to engine failure.
- ❗ Your vehicle's warranty may be invalidated if damage is caused by the use of unapproved engine oil.
- ❗ Do not use oil additives of any type as engine damage could occur. Use only specified lubricants.

Model	Specification
V6 Petrol engines	SAE 5W-30 engine oil meeting Jaguar specification WSS M2C913-C is preferred. Oil meeting ACEA A1/B1 or ACEA A3/B3 specification may be used.
V8 Petrol engines	SAE 5W-20 meeting Jaguar specification WSS M2C925-A only.
Diesel engines	5W-30 engine oil, meeting Jaguar specification WSS M2C934-B only.
Japan V6 Petrol engines	SAE 5W-30 engine oil meeting specification ILSAC GF-4 with API SM is preferred. Oil meeting ILSAC GF-3 API SL specification may be used.
Japan V8 Petrol engines	SAE 5W-20 engine oil meeting Jaguar specification WSS M2C925-A only.

Fluid level checks

Jaguar recommends:



TOPPING UP THE OIL

⚠ Overfilling with oil could result in severe engine damage.

1. Unscrew the oil filler cap.
2. Add oil as indicated by the message centre display.
3. Wait five minutes for the oil level to stabilise then re-check.

It is essential to use the correct specification oil, and to ensure it is suitable for the climatic conditions in which the vehicle is to be operated.

ENGINE OIL CONSUMPTION

A certain amount of oil consumption is normal. The rate of consumption will depend on the following:

- The quality and viscosity of the oil.
- Climatic conditions.
- The speed at which the engine is being operated.
- Road conditions.

Drivers should expect above normal consumption when the engine is new, and after running-in if high speeds are sustained.

CHECKING THE COOLANT LEVEL

- ⚠ Running the engine without coolant will cause serious engine damage.
- ⚠ If persistent coolant loss is noticed, seek qualified assistance immediately.

The coolant level in the expansion tank should be checked at least weekly (more frequently in high mileage or severe operating conditions). Always check the level when the system is cold.

Ensure the coolant level is maintained between the level indicator marks, as shown in the illustrations.



Diesel engines

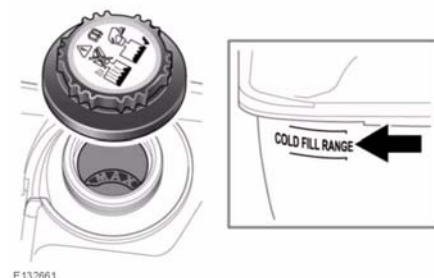

Petrol engines

If the message **LOW COOLANT LEVEL** is displayed in the message centre, stop the vehicle as soon as safety permits and top-up the coolant reservoir with the recommended antifreeze/water mix.

If the message centre displays the message **ENGINE OVERHEATING**, pull off the carriageway and allow the engine to idle for five minutes and then switch off the ignition for ten minutes. Switch on the engine and, provided that the warning does not occur, continue your journey, avoiding harsh acceleration. Seek qualified assistance as soon as possible.

TOPPING UP THE COOLANT



Never remove the filler cap when the engine is hot.



Antifreeze is highly inflammable. Do not allow antifreeze to come into contact with naked flames or other sources of ignition (e.g. a hot engine) - a fire may result.



Unscrew the filler cap slowly, allowing the pressure to escape before removing completely.



When travelling in territories where the water supply contains salt, always ensure you carry a supply of fresh (rain or distilled) water. Topping up with salt water will cause serious engine damage.

Top-up to the upper level indicator mark located on the side of the expansion tank. Use only a 50% mix of water and antifreeze to specification WSS M97B44 (coloured orange) Extended Life Coolant.

Ensure the cap is tightened fully after top-up is completed by turning the cap until the ratchet cap clicks.

***Note:** In an emergency, if the approved antifreeze is unavailable, top-up the system with clean water, but be aware of the resultant reduction in frost protection. Do not top-up or refill with conventional antifreeze formulations. If in doubt consult a qualified technician.*

BRAKE FLUID CHECK



Seek qualified assistance immediately if brake pedal travel is unusually long, unusually short or if there is any significant loss of brake fluid. Driving under such conditions could result in extended stopping distances or complete brake failure.



If the quantity of fluid in the brake reservoir drops below the recommended level, a red warning lamp in the instrument panel will illuminate and the message Brake Fluid Low will be displayed in the message centre.

***Note:** If the warning lamp illuminates or the message is displayed while the vehicle is being driven, stop the vehicle as soon as safety permits by gently applying the brakes. Check and top-up the fluid level if necessary.*



Brake fluid is highly toxic - keep containers sealed and out of the reach of children. If accidental consumption is suspected, seek medical attention immediately.



If the fluid comes into contact with the skin or eyes, rinse immediately with plenty of water.



Brake fluid is highly inflammable. Do not allow brake fluid to come into contact with naked flames or other sources of ignition (e.g. a hot engine).

Fluid level checks

⚠ Do not drive the vehicle with the fluid level below the MIN mark.

With the vehicle on level ground, check the fluid level at least every week (more frequently in high mileage or arduous operating conditions).

The brake fluid reservoir is located beneath a cover on the raised platform to the rear of the main underbonnet area.

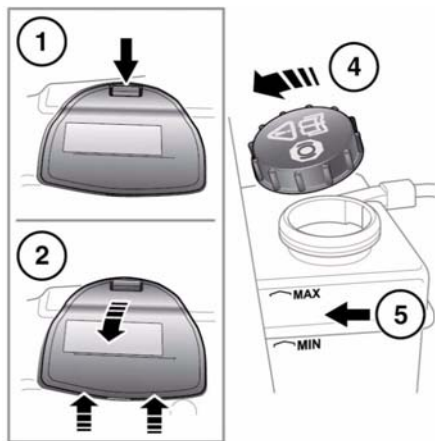

E134346

1. Release the catch and lift the cover forwards.
2. Pull the cover rearwards, to release the hinges.
3. Clean the filler cap with a clean, dry cloth before removing, to prevent dirt or moisture from entering the reservoir.
4. Remove the filler cap.
5. The brake fluid level should be between the **MIN** and the **MAX** marks on the side of the reservoir.







The fluid level may drop slightly during normal use, as a result of brake pad wear, but should not be allowed to drop below the **MIN** mark.

TOPPING UP THE BRAKE FLUID

- ⚠ Brake fluid will damage painted surfaces. Soak up any spillage with an absorbent cloth immediately and wash the area with a mixture of car shampoo and water.
- ⚠ Only use new fluid from an airtight container (fluid from open containers or fluid previously bled from the system, will have absorbed moisture, which will adversely affect performance, and must not be used).
- ⚠ **Top up the brake fluid with Shell DOT ESL brake fluid.** If unavailable, use a low viscosity brake fluid that meets ISO 4925 class 6 specification. Only fluid of this type and standard may be used.
- ⚠ Do not top up the brake fluid to the maximum mark unless the brake pads have been replaced. If unsure, seek qualified assistance.

1. Top up the reservoir to at least the minimum mark.
2. Replace the reservoir cap.
3. Refit the reservoir cover.

POWER STEERING FLUID CHECK



-  Power steering fluid is highly toxic. Keep containers sealed and out of reach of children. If accidental consumption of fluid is suspected, seek medical attention immediately.
-  If the fluid comes into contact with the skin or eyes, rinse immediately with plenty of water.
-  Power steering fluid is highly inflammable. Do not allow power steering fluid to come into contact with naked flames or other sources of ignition (e.g. a hot engine).
-  The engine must not be started if the fluid level has dropped below the **MIN** mark.
-  Seek qualified assistance immediately if there is a noticeable drop in the fluid level.
-  If fluid loss is slow, the reservoir may be topped-up to the upper level mark to enable the vehicle to be driven to a repair facility for examination. However, it is recommended that you seek qualified assistance before driving the vehicle.

Check and top-up the fluid with the vehicle on level ground, with the engine switched off and the system cold. Ensure that the steering wheel is not turned after stopping the engine.

The level of fluid can be seen through the translucent body of the reservoir.

The fluid level should be between the **MIN** and the **MAX** marks.

TOPPING UP THE POWER STEERING FLUID

-  It is imperative that the power steering system does not become contaminated in any way. Always use new fluid and clean the area around the filler neck both before removing the filler cap and after topping up. Never return drained fluid to the system.
 -  Power steering fluid will damage painted surfaces. Soak up any spillage with an absorbent cloth immediately and wash the area with a mixture of car shampoo and water.
1. Clean the filler cap before removing to prevent dirt from entering the reservoir.
 2. Remove filler cap.
 3. Using Mobil ATF320 PAS fluid, top-up the reservoir until the fluid level is between the **MIN** and **MAX** marks.
 4. Replace filler cap.

Fluid level checks

CHECKING THE WASHER FLUID



Do not allow screen washer fluid to come into contact with naked flames or sources of ignition.



If the vehicle is operated in temperatures below 4°C (40°F), use a washer fluid with frost protection.



Only use approved washer fluid.



Take care to avoid spillage, particularly if an undiluted or high concentration is being used. If spillage occurs, wash the affected area immediately with water.

The washer reservoir supplies the windscreen and headlamp washer jets.

Check and top-up the reservoir level at least every week.

Fill with Jaguar Windscreen Washer Fluid, diluted with clean water, as specified in the instructions on the bottle. Using a non-approved fluid may adversely affect the wiper blade rubber, resulting in ineffectual and noisy wiping.

Operate the washers periodically to check that the nozzles are clear and properly directed.

TOPPING UP THE WASHER FLUID

1. Clean the filler cap before opening to prevent dirt from entering the reservoir.
2. Open filler cap.
3. Top-up the reservoir until the fluid is visible in the filler neck.
4. Close filler cap.

ENGINE SPECIFICATIONS

Data	I4 Diesel	V6 Diesel	V6 Petrol	V8 Petrol (Normally Aspirated)	V8 Petrol (Supercharged)
Number of cylinders	4	6	6	8	8
Displacement (cc)	2179	2993	2967	5000	5000
Compression ratio	15.8:1	16.1:1	10.5:1	11.5:1	9.5:1

LUBRICANTS AND FLUIDS

Part	Variant	Specification
Engine oil	V6 Petrol engines	SAE 5W-30 engine oil meeting Jaguar specification WSS M2C913-C is preferred. Oil meeting ACEA A3/B3 specification may be used.
	V8 Petrol engines	SAE 5W-20 engine oil meeting Jaguar specification WSS M2C925-A only.
	Diesel engines	SAE 5W-30 engine oil meeting Jaguar specification WSS M2C934-B only.
	Japan V6 Petrol engines	SAE 5W-30 engine oil meeting specification ILSAC GF-5 with API SM is preferred. Oil meeting ILSAC GF-4 API SL specification may be used.
	Japan V8 Petrol engines	SAE 5W-20 engine oil meeting Jaguar specification WSS M2C925-A only.
Power steering fluid	All vehicles	Mobil ATF320 PAS fluid.
Brake fluid	All vehicles	Shell DOT4 ESL is preferred. If unavailable, a low viscosity brake fluid that meets ISO 4925 class 6 specification may be used.
Screen washer	All vehicles	Screen wash with frost protection.
Coolant	All vehicles	50% mixture of water and antifreeze specification WSS M97B44 (coloured orange) Extended Life Coolant.
If in doubt about the required specification of a lubricant or fluid for your vehicle, seek advice from your Dealer/Authorised Repairer.		

Technical specifications

WEIGHTS

Variant	Vehicle weight from	Front axle weight from	Rear axle weight from	Max. luggage compartment load ¹
I4 Diesel	1745 kg 3847 lb	932 kg 2054 lb	813 kg 1793 lb	35 kg 77 lb
V6 Diesel	1810 kg 3990 lb	1011 kg 2229 lb	799 kg 1761 lb	35 kg 77 lb
V6 Petrol	1690 kg 3726 lb	883 kg 1947 lb	807 kg 1779 lb	35 kg 77 lb
V8 Normally Aspirated Petrol	1780 kg 3924 lb	961 kg 2119 lb	819 kg 1806 lb	35 kg 77 lb
V8 Supercharged Petrol	1891 kg 4169 lb	1022 kg 2253 lb	869 kg 1916 lb	35 kg 77 lb

¹The maximum permitted luggage compartment load can be exceeded, provided the requirements regarding the maximum permissible axle weights and tyre pressures are followed.



The maximum permitted roof load, including the weight of the roof rack/ roof bars, is 75 kg (165 lb). The roof load must be included when calculating the Gross Vehicle Weight (GVW).



Jaguar recommend that only approved accessories are used. If in any doubt, consult your Jaguar Dealer/ Approved Repairer before fitting a roof rack/ roof bars or carrying a roof load.

Variant	Gross Vehicle Weight (GVW) ¹	Maximum front axle load²	Maximum rear axle load ²	Gross Train Weight³
I4 Diesel	2320 kg 5115 lb	1200 kg 2646 lb	1230 kg 2712 lb	4170 kg 9193 lb
V6 Diesel	2360 kg 5203 lb	1215 kg 2679 lb	1215 kg 2679 lb	4210 kg 9281 lb
V6 Petrol	2215 kg 4883 lb	1090 kg 2403 lb	1180 kg 2601 lb	4065 kg 8962 lb
V8 Normally Aspirated Petrol	2300 kg 5071 lb	1150 kg 2535 lb	1215 kg 2679 lb	Not Applicable
V8 Supercharged Petrol	2370 kg 5225 lb	1185 kg 2612 lb	1250 kg 2756 lb	Not Applicable
<p>¹ The maximum permissible weight of the vehicle including passengers and load.</p> <p>² The front and rear axle maximum loads can not be reached simultaneously as this will exceed the GVW limit.</p> <p>³ The maximum permissible weight of the vehicle and braked trailer, including their respective loads.</p>				

Technical specifications

DIMENSIONS

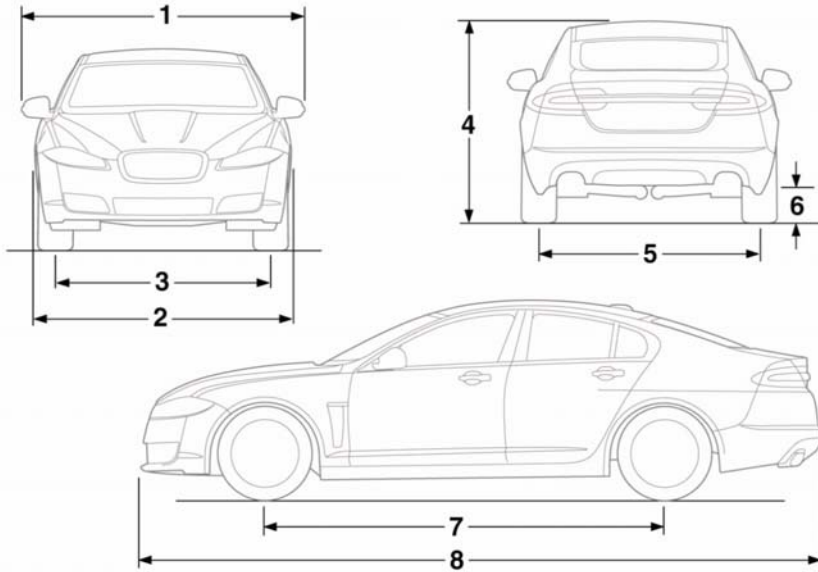

E134579

Item	Description	mm/inches
1	Width	2077/81.8
2	Width with mirrors folded	1920/75.6
3	Track - front	1559/61.4
4	Maximum height	1460/57.5
5	Track - rear ¹	1571-1605/61.9-63.2
6	Minimum ground clearance (at gross vehicle weight):	96/3.8
7	Wheelbase	2909/114.5
8	Length excluding license plate plinth	4961/195.3
-	Turning circle (kerb to kerb)	11.5 m/37.7 ft.

¹The narrowest dimension applies to 20 inch wheels only.

CAPACITIES

Item	Variant	Capacity
Fuel tank (usable)	Diesel	68.1 litres (15 gallons)
	Petrol	69.5 litres (15.3 gallons)
Fuel capacity (when the fuel gauge indicates empty)	Diesel	64 litres (14.1 gallons)
	Petrol	64 litres (14.1 gallons)
Reserve capacity (when the fuel gauge indicates empty)	Diesel	5.5 litres (1.2 gallons)
	Petrol	5.5 litres (1.2 gallons)
Engine oil refill and filter change	I4 Diesel	5.86 litres (10.3 pints)
	V6 Diesel	6.4 litres (11.3 pints)
	V6 Petrol	6.5 litres (11.4 pints)
	V8 Petrol	7.25 litres (12.8 pints)
Washer reservoir	With headlamp wash	5.5 litres (9.7 pints)
	Without headlamp wash	4.4 litres (7.7 pints)
Cooling system (fill from dry)	I4 Diesel	11.56 litres (20.3 pints)
	V6 Diesel	12.5 litres (22 pints)
	V6 Petrol	9.25 litres (16.3 pints)
	V8 Petrol (Normally Aspirated)	12.5 litres (22 pints)
	V8 Petrol (Supercharged)	12.3 litres (21.6 pints)
Cooling system (service fill)	I4 Diesel	8.2 litres (14.4 pints)
	V6 Diesel	9.7 litres (17.1 pints)
	V6 Petrol	7.42 litres (13.1 pints)
	V8 Petrol (Normally Aspirated)	7.5 litres (13.2 pints)
	V8 Petrol (Supercharged) - both drain points used	8.6 litres (15.1 pints)

The quoted capacities are approximate and provided as a guide only. All levels must be checked using the level marks or information displayed in the message centre, as applicable.

Technical specifications

WHEEL ALIGNMENT DATA (CHINA)

Wheel alignment - front	+ 0.22°
Wheel alignment - rear	+0.17°
Camber - front LH	-0.20°
Camber - front RH	-0.40°
Camber - rear	-0.78°
Castor - front	6.61°
Castor - rear	Non-adjustable

BRAKE PEDAL TRAVEL (CHINA)

The brake pedal travel is set at the factory and is non-adjustable.

ACCESSORY WHEELS AND TYRES



1 _____ 2 _____

3 _____

E132663

1. Front tyre pressure.
2. Rear tyre pressure.
3. Wheel and tyre information (size, speed rating, etc.).

Note: Use the table above to record accessory wheel and tyre information.



Contact your Dealer/Authorised Repairer before fitting any accessory wheels and tyres.

REMOTE KEY FOB TRANSMITTER LOCATIONS

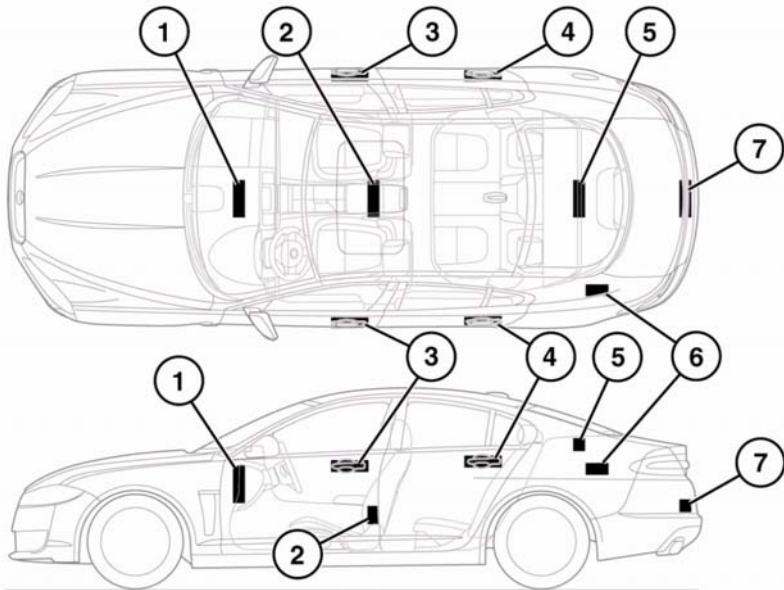

E134580

1. Cabin front transmitter.
2. Cabin rear transmitter.
3. Front exterior door handle transmitters.
4. Rear exterior door handle transmitters.
5. Luggage compartment interior transmitter.
6. Luggage compartment exterior transmitter.
7. Keyless vehicle module.



Any person fitted with an implanted medical device should ensure that the device is kept at a distance of at least 22 cm (8.7 inches) away from any transmitter mounted in the vehicle. This is to avoid any possibility of interference between the system and device.

Vehicle battery

BATTERY WARNING SYMBOLS



Do not allow naked flames or other sources of ignition near the battery, as the battery may emit explosive gases.



Ensure that when working near or handling the battery, suitable eye protection is worn, to protect the eyes from acid splashes.



To prevent risk of injury, do not allow children near the battery.



Be aware that the battery may emit explosive gases.



The battery contains acid which is extremely corrosive and toxic.



Consult the handbook for information, before handling the battery.

BATTERY CARE



If battery electrolyte comes into contact with your eyes, skin, or clothes you should remove the affected clothing and flush the skin/eyes with copious amounts of water. Seek medical assistance immediately.



If swallowed, battery electrolyte can be fatal, seek medical assistance immediately.



Do not connect any 12 volt equipment directly to the battery terminals. Doing so may cause a spark, which can result in an explosion.



The cell plugs and vent pipe must be in place at all times when the battery is connected to the vehicle. Ensure that the vent pipe is clear of obstructions and not kinked. Failure to do so may cause a pressure build up in the battery, resulting in an explosion.



Do not expose the battery to a naked flame or spark as the battery produces explosive, flammable gas.



Never jump start (boost), charge, or try to start a vehicle with a frozen battery. Doing so can result in an explosion.



Remove all metal jewellery before working on, or near, the battery, and never allow metal tools or vehicle components to come into contact with the battery terminals.



Do not allow the battery posts or terminals to come into contact with your skin. They contain lead and lead compounds, which are toxic. Always wash your hands thoroughly after handling the battery.



Do not allow battery electrolyte to come into contact with fabrics or painted surfaces. If battery electrolyte comes into contact with any surface, the surface should be washed down immediately with copious amounts of clean water.

Vehicles may be fitted with either a single low maintenance battery or dual maintenance free batteries. Both types are located under the floor of the luggage compartment.

If the vehicle is fitted with a single battery, in hot climates more frequent checks of the battery electrolyte level and condition are required. If necessary, the battery cells can be topped up using distilled water.

BATTERY MONITORING SYSTEM (BMS)

If excessive battery discharge is occurring when the engine isn't running, the system will shut down non-essential electrical systems to protect battery power.

CONNECTING BOOSTER CABLES



Always wear appropriate eye protection when working with batteries.



Make sure both batteries are of the 12 volt type and that the booster cables have insulated clamps and are approved for use with 12 volt batteries.



Do not disconnect the discharged battery.



Do not connect a booster cable to the negative (-) terminal of the battery. Always connect to the recommended earthing point.



Ensure the bodywork of the donor and disabled vehicles do not touch.



If the vehicle is fitted with a dual battery system, the larger of the two batteries must be used when connecting booster cables.

Note: Before connecting booster cables, ensure that the battery connections on the disabled vehicle are correct and that all electrical equipment has been switched off.

1. Connect the positive booster cable to the positive terminal on the donor vehicle's battery.
2. Connect the other end of the positive booster cable to the positive terminal on the disabled vehicle's battery.



If the vehicle is fitted with a dual battery system, the larger of the two batteries must be used when connecting booster cables.

3. Connect the negative booster cable to the recommended jump starting earth point of the donor vehicle.
4. Connect the other end of the negative booster cable to a suitable earth point on the disabled vehicle. The earth point should be at least 0.5 metres (20 inches) away from the battery and as far as possible from any fuel or brake pipes.
 - Check that all cables are clear of any moving components and that all four connections are secure.
5. Start the engine of the donor vehicle, and allow it to idle for a few minutes.
6. Start the engine of the disabled vehicle.
7. Allow both vehicles to idle for two minutes.
8. Switch off the donor vehicle.

DISCONNECTING THE BOOSTER CABLES



To avoid serious injury use extreme caution when removing the booster cables as the engine will be running on the previously disabled vehicle. This means that you may be working close to components which are moving at high speed, carry high voltage, or may be hot.

Note: Do not switch on any electrical equipment until after the cables have been disconnected.

The engine should be running on the previously disabled vehicle and the engine switched off on the donor vehicle. Disconnect the booster cables in the exact reverse order of that used for connection.

Vehicle battery

CHARGING THE VEHICLE BATTERY

- ⚠ The battery must be disconnected and removed from the vehicle before charging.
- ⚠ Battery disconnection, removal and replacement, should only be carried out by qualified personnel. Consult your Dealer/Authorised Repairer.





REPLACING THE VEHICLE BATTERY

- ⚠ Battery disconnection, removal and replacement, should only be carried out by qualified personnel. Consult your Dealer/Authorised Repairer.





Used batteries must be disposed of correctly, as they contain a number of harmful substances. Seek advice from your Dealer/Authorised Repairer and/or your local authority.

TYRE CARE

-  Do not drive the vehicle if a tyre is damaged, excessively worn, or incorrectly inflated.
-  Avoid contaminating the tyres with vehicle fluids as they may cause damage to the tyre.
-  Avoid spinning the wheels. The forces released can damage the structure of the tyre and cause it to fail.
-  If wheel spin is unavoidable due to a loss of traction (in deep snow, for example), do not exceed 50 km/h (30 mph).
-  Do not exceed the maximum pressure stated on the sidewall of the tyre.

TYRE PRESSURES

-  Never drive your vehicle if the tyre pressures are incorrect.
-  Pressure checks should only be carried out when the tyres are cold, and the vehicle has been stationary for more than three hours. A hot tyre at or below recommended cold inflation pressure is dangerously under-inflated.
-  If the vehicle has been parked in strong sunlight, or used in high ambient temperatures, do not reduce the tyre pressures. Move the vehicle into the shade and allow the tyres to cool before re-checking the pressures.

CHECKING THE TYRE PRESSURES

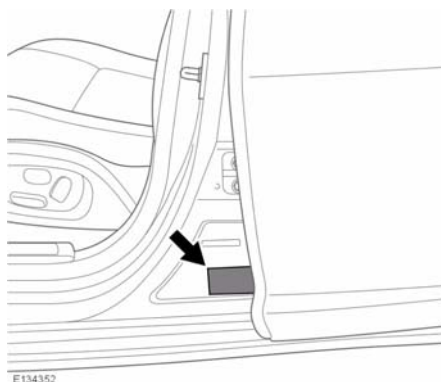

The recommended tyre pressures are listed on a label located in the driver's door opening.

Check the tyres, including the spare, for condition and pressure on a weekly basis and before long journeys.

If tyre pressures are checked while the vehicle is inside a protected covered area (e.g. a garage) and subsequently driven in lower outdoor temperatures, tyre under-inflation could occur.

A slight pressure loss occurs naturally with time. If this exceeds 0.14 bar (2 psi, 14 kPa,) per week, have the cause investigated and rectified by qualified assistance.

If it is necessary to check tyre pressures when the tyres are warm, you should expect the pressures to have increased by up to 0.3 - 0.4 bar (4 - 6 psi, 30 - 40 kPa). Do not reduce the tyre pressures to the cold inflation pressure under these circumstances. Allow the tyres to cool fully before adjusting the pressures.

TYRE VALVES

Keep the valve caps screwed down firmly to prevent water or dirt entering the valve. Check the valves for leaks when checking the tyre pressures.

PUNCTURED TYRES



Do not drive the vehicle with a punctured tyre. Even if the punctured tyre has not deflated, it is unsafe to use, as the tyre may deflate suddenly at any time.

REPLACEMENT TYRES



Always fit replacement tyres of the same type, and wherever possible of the same make and tread pattern.



If the use of tyres not recommended by Jaguar is unavoidable, ensure that you read, and fully comply with, the tyre manufacturer's instructions.

Ideally, tyres should be replaced in sets of four. If this is not possible, replace the tyres in pairs (both front or both rear). When tyres are replaced, the wheels should always be re-balanced and alignment checked.

The correct tyre specification for your vehicle can be found on the tyre placard label.

PRESSURE COMPENSATION FOR TEMPERATURE CHANGES

A colder ambient local temperature will reduce pressure within the tyre. An effect is to decrease sidewall height and to increase tyre shoulder wear with the potential for tyre failure. Vehicle dynamics could also be adversely affected.

Tyre pressures can be adjusted to compensate before the start of the journey. Alternatively, tyre pressures can be adjusted when the area of lower ambient temperature is reached.

In this situation, the vehicle must be left in the ambient local temperature for at least one hour before tyre pressure is adjusted.

To compensate for colder ambient temperatures, tyre pressures should be increased by 0.14 bar (2 psi, 14 kPa) for each 10°C (20°F) decrease.

Note: *Ensure that correct tyre pressures are maintained when moving to areas of differing ambient temperature.*

AVOIDING FLAT SPOTS

In order to minimise flat spotting, the tyre pressures can be increased to the maximum as stated on the tyre sidewall, for the period when the vehicle is stationary. Tyres must be returned to the specified running pressures before driving.

TYRE DEGRADATION

Tyres degrade over time due to the effects of ultraviolet light, extreme temperatures, high loads, and environmental conditions. It is recommended that tyres are replaced at least every six years, but they may require replacement more frequently.

USING WINTER TYRES

Do not exceed 240 km/h (150 mph) when using Jaguar approved winter tyres.

Winter tyres must be fitted to all four wheels.



Note: *Tyres with an all season icon or M+S have a level of winter performance and need not be replaced.*

APPROVED WINTER TYRE SIZES

Front:

- Dunlop Wintersport M3 - 235/55R17 99H, 245/45R18 96V, 245/45R18 100V, 245/40R19 98V.
- W240 Pirelli Sotto Zero - 245/45R18 100V, 245/40R19 98V, 255/35R20 97V.

Rear:

- Dunlop Wintersport M3 - 235/55R17 99H, 245/45R18 96V, 245/45R18 100V, 245/40R19 98V.
- W240 Pirelli Sotto Zero - 245/45R18 100V, 245/40R19 98V, 285/30R20 97V.

WINTER TYRE PRESSURES

Up to 210 km/h (130 mph)	
17 inch Wheels - Front and Rear	2.3 bar (34 psi, 230 kPa)
18 inch Wheels - Front and Rear	2.4 bar (35 psi, 240 kPa)
19 inch Wheels - Front and Rear	2.6 bar (38 psi, 260 kPa)
20 inch Wheels - Front and Rear	2.7 bar (40 psi, 270 kPa)

USING SNOW CHAINS



It is essential that only snow chains of the recommended type are fitted.

Snow chains can only be fitted to rear wheels. They should not be used on temporary use spare wheels.

Contact your Dealer/Authorised Repairer for details and availability of approved snow chains.

The maximum speed when using snow chains is 50 km/h (30 mph).

Note: When using snow chains, select JaguarDrive Control Winter mode **and** switch DSC off. DSC would reduce the deep snow traction capability as it would limit wheel spin to a level below that which is required to generate maximum traction.

FUSE BOX LOCATIONS

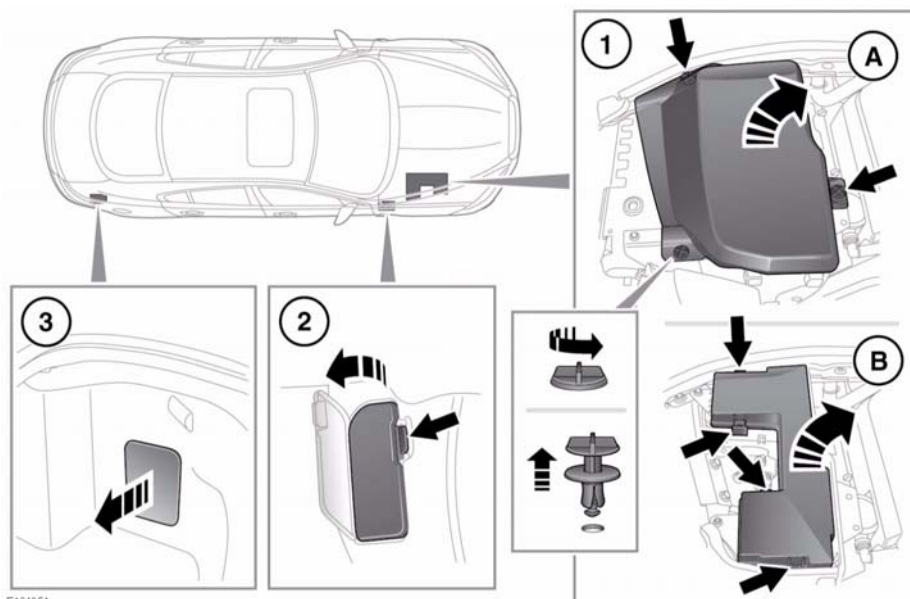

E134351

- ⚠ When a fuse box lid is removed, take care to protect the box from moisture, and refit the lid at the earliest opportunity.

There are three separate fuse boxes fitted to the vehicle, each one containing fuses protecting a different group of circuits.

1. The engine compartment fuse box.
 - Release the turnbuckles and remove engine cover.
 - Press the release catches and remove fuse box cover.
2. The passenger compartment fuse box.
3. The luggage compartment fuse box.

CHANGING A FUSE

- ⚠ Always turn off the ignition system and the affected electrical circuit, before replacing a fuse.
- ⚠ Fit Jaguar approved replacement fuses of the same rating and type, or fuses of matching specification.
- ⚠ If the replacement fuse blows after installation, the system should be checked by your Dealer/Authorised Repairer.

Note: Jaguar recommend that owners do not remove or replace relays. It is recommended that you seek qualified assistance in the event of a relay failure.

Spare fuses and a fuse removal tool, are located in the engine compartment fuse box.

ENGINE COMPARTMENT FUSE BOX

Fuse No	Rating (amps)	Fuse Colour	Circuit
F1	-	-	-
F2	-	-	-
F3	20A	Yellow	Emissions system (petrol only).
F4	20A	Yellow	Emissions system (petrol only).
F5	40A	Orange	ABS pump.
F6	30A	Green	Power wash pump.
F7	50A	Red	Cigar lighter.
F8	-	-	-
F9	50A	Red	Engine management system.
F10	-	-	-
F11	-	-	-
F12	50A	Red	Secondary air injection (V6 petrol only).
F13	30A	Green	Wipers.
F14	30A	Green	Starter solenoid.
F15	40A	Orange	Front screen heater - RH.
F16	40A	Orange	Front screen heater - LH.
F17	80A	Natural	Radiator fan (V6 petrol only).
F18	60A	Aqua	Glow plugs (diesel only).
F19	5A	Tan	Adaptive cruise control. FLS.
F20	15A	Blue	Horn.
F21	25A	Clear	ABS valves.
F22	-	-	-
F23	-	-	-
F24	-	-	-
F25	10A	Red	ABS ECM.
F26	10A	Red	Engine management system ECM. Transmission control module.
F27	5A	Tan	Secondary air injection (V6 petrol only).
F28	5A	Tan	Adaptive front lighting - LH.
F29	5A	Tan	Adaptive front lighting - RH.

Fuses

Fuse No	Rating (amps)	Fuse Colour	Circuit
F30	-	-	-
F31	20A	Yellow	Auxiliary power socket - rear.
F32	20A	Yellow	Cigar lighter.
F33	-	-	-
F34	-	-	-
F35	5A	Tan	Air conditioning compressor clutch.
F36	15A	Blue	Engine management system 5 (V6 diesel only).
	20A	Yellow	Engine management system 5 (V8 petrol only).
F37	15A	Blue	Ignition system (petrol only).
F38	5A	Tan	Power steering.
F39	5A	Tan	Headlamp levelling system.
F40	15A	Blue	Water pump (supercharged vehicles only).
F41	5A	Tan	Engine management system 1 (V6 diesel only).
	10A	Red	Engine management system 1 (petrol and I4 diesel only).
F42	10A	Red	Engine management system 2 (V8 petrol only).
	20A	Yellow	Engine management system 2 (I4 diesel only).
	30A	Green	Engine management system 2 (V6 petrol and V6 diesel only).
F43	5A	Tan	Engine management system 3 (diesel only).
	10A	Red	Engine management system 3 (petrol only).
F44	5A	Tan	Engine management system 4 (V6 diesel only).
	10A	Red	Engine management system 4 (I4 diesel only).
	15A	Blue	Engine management system 4 (V8 petrol only).
F45	100A	Violet	Radiator fan (diesel and V8 petrol only).

PASSENGER COMPARTMENT FUSE BOX

Fuse No	Rating (amps)	Fuse Colour	Circuit
F1	-	-	-
F2	-	-	-
F3	20A	Yellow	Driver's seat adjustment.
F4	20A	Yellow	Driver's seat adjustment.
F5	-	-	-
F6	-	-	-
F7	-	-	-
F8	20A	Yellow	Front passenger's seat adjustment.
F9	20A	Yellow	Front passenger's seat adjustment.
F10	20A	Yellow	Left-hand rear door controls.
F11	20A	Yellow	Right-hand rear door controls.
F12	-	-	-
F13	10A	Red	Steering column adjust.
F14	-	-	-
F15	-	-	-
F16	5A	Tan	Sunblind.
F17	-	-	-
F18	-	-	-
F19	-	-	-
F20	5A	Tan	Remote control receiver.
F21	5A	Tan	Foot brake.
F22	5A	Tan	Electric parking brake.
F23	5A	Tan	Driver's seat. Audio system. Auto headlamps. Upper centre console switches.
F24	10A	Red	Front passenger seat. Electric windows. Mirror adjustment.
F25	20A	Yellow	Driver's heated/climate seat.
F26	15A	Blue	Trailer power socket. Road pricing system.
F27	20A	Yellow	Front passenger's heated/climate seat.
F28	15A	Blue	Auxiliary power sockets.
F29	20A	Yellow	Keyless entry system.

Fuses

Fuse No	Rating (amps)	Fuse Colour	Circuit
F30	10A	Red	Air conditioning.
F31	15A	Blue	Sunroof.
F32	5A	Tan	Starter control unit.
F33	5A	Tan	Diagnostic connector.
F34	5A	Tan	Instrument pack.
F35	15A	Blue	Interior lamps.
F36	10A	Red	Suspension system.

LUGGAGE COMPARTMENT FUSE BOX











Fuse No	Rating (amps)	Fuse Colour	Circuit
F1	30A	Green	Air blower.
F2	30A	Green	Electric parking brake.
F3	-	-	-
F4	-	-	-
F5	-	-	-
F6	-	-	-
F7	30A	Green	Heated rear screen.
F8	30A	Green	Audio system (premium audio only).
F9	50A	Red	RBD link.
F10	40A	Orange	Rear electronic differential (e-Diff).
F11	-	-	-
F12	-	-	-
F13	-	-	-
F14	5A	Tan	Telephone.
F15	10A	Red	TV. DVD. DAB radio.
F16	-	-	-
F17	-	-	-
F18	-	-	-
F19	-	-	-
F20	-	-	-
F21	-	-	-





Fuse No	Rating (amps)	Fuse Colour	Circuit
F22	-	-	-
F23	-	-	-
F24	-	-	-
F25	25A	Clear	Fuel pump.
F26	15A	Blue	Audio system. Portable audio interface.
F27	10A	Red	Navigation. Voice recognition. Touch screen.
F28	15A	Blue	Trailer power connector. Road pricing system.
F29	15A	Blue	Trailer connector.
F30	25A	Clear	Driver's door module.
F31	25A	Clear	Front passenger door module.
F32	-	-	-
F33	5A	Tan	Tyre pressure monitoring system.
F34	-	-	-
F35	10A	Red	Supplementary restraint system.
F36	10A	Red	Pedestrian protection system.

Wheel changing

WHEEL CHANGING SAFETY

Before raising the vehicle, or changing a wheel ensure that you read, and comply with the following warnings.

-  Always find a safe place to stop, off the highway and away from traffic.
-  Ensure that the vehicle and jack are both on firm level ground.
-  Apply the parking brake, and engage Park (P).
-  Switch on the hazard warning lamps.
-  Ensure that the front wheels are in the straight ahead position, and engage the steering lock.
-  Disconnect trailer/caravan from the vehicle.
-  Ensure that all passengers, and animals, are out of the vehicle and in a safe place away from the highway.
-  Place a warning triangle at a suitable distance behind the vehicle, facing towards oncoming traffic.
-  When one rear wheel is lifted off the ground the selection P (Park) position will not prevent the vehicle from moving and possibly slipping off the jack as the park brake only operates on the rear wheels. Use the wheel chock when jacking the vehicle.
-  Always chock the wheel diagonally opposite the wheel to be changed, using the wheel chock supplied in the tool kit. Chock the front of a front wheel, or the rear of a rear wheel.
-  If jacking the vehicle on a slight slope is unavoidable, place chocks on the downhill side of the two opposite wheels. An additional chock will be needed.

-  Never place anything between the jack and the ground, or the jack and the vehicle.
-  Do not attempt to raise the vehicle unless the jack head is fully engaged in the jacking point. Only jack the vehicle using the approved jacking points.
-  Remove the spare wheel prior to jacking the vehicle, to avoid destabilising the vehicle when raised.
-  Take care when lifting the spare wheel, and removing the punctured wheel. The wheels are heavy, and can cause injuries if not handled correctly.
-  Do not start or run the engine while the vehicle is supported only by a jack.
-  Do not get under a vehicle that is supported by a jack.
-  Never work or allow any person to place any part of their body beneath the vehicle with the jack as the only means of support - use vehicle support stands.
-  Take care when loosening the wheel nuts. The wheel brace may slip off if not properly attached, and the wheel nuts may release suddenly. Either unexpected movement may cause an injury.
-  After use, the tool kit should be returned to the under floor storage area and correctly stowed.
-  Always ensure replacement tyres have the correct rating and specifications (e.g. load index, size, speed rating) for your vehicle.

WHEEL CHANGING

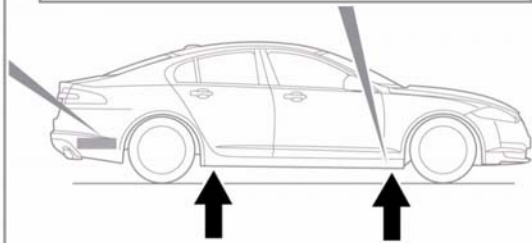
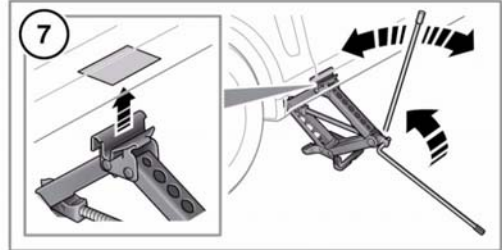
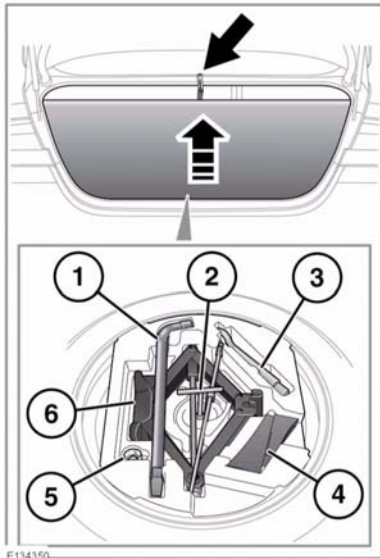

⚠ Do not get under a vehicle that is supported by a jack.

Before raising the vehicle slacken but do not remove the wheel nuts.

1. Wheel brace.
2. Spare wheel retaining T-bar.
3. Towing eye.
4. Wheel chock.
5. Locking wheel nut adaptor.
6. Jack. Observe the instructions printed on the jack.
7. There are four jacking points on the underside of the floor. Two indented, triangular indicators are provided on each sill cover. These indicate the location for the jack.

Carefully raise the vehicle by turning the jack handle. Stop jacking the vehicle when the tyre just clears the ground. Minimum tyre lift gives maximum vehicle stability.

To remove the spare wheel, unscrew and remove the bolt through the centre.







Fit the spare wheel and loosely secure with the wheel nuts.

Note: To remove the centre badge use the plastic tipped end of the wheel nut wrench handle, push the centre badge from its housing from the inside of the wheel.

Wheel changing

TEMPORARY USE SPARE WHEEL

Observe the following warnings before using the wheel:

-  **Always adhere to the instructions given on the temporary use spare wheel warning label. Failure to comply can be dangerous.**
-  **When a temporary use spare wheel is fitted, drive with caution and replace with the specified wheel and tyre as soon as possible.**
-  **Do not fit more than one temporary use spare wheel and tyre assembly at one time.**
-  **The temporary use spare wheel must be inflated to 4.2 bar (60 psi, 420 kPa) and cannot be repaired.**
-  **Temporary use spare wheel, maximum speed is 80 km/h (50 mph).**
-  **DSC must be on when the temporary use spare wheel is in use.**

LOCKING WHEEL NUTS

Note: A code number is stamped on the side of the locking nut. Ensure the number is recorded on the Security Card supplied with the literature pack. Quote this number if a replacement is required. Do not keep the Security Card in the vehicle.

TIGHTENING THE WHEEL NUTS

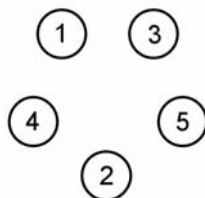

E132675

Using the wheel nut wrench, lightly tighten the wheel nuts alternately using the sequence shown in the illustration.

Lower the jack, then tighten the wheel nuts fully, in the same sequence shown. Do not overtighten by using foot pressure or extension bars on the wheel nut wrench.

At the earliest opportunity have the wheel nuts tightened with a torque wrench to 125 Nm (92 lb.ft).

This torque must not be exceeded.

TOWING EYES

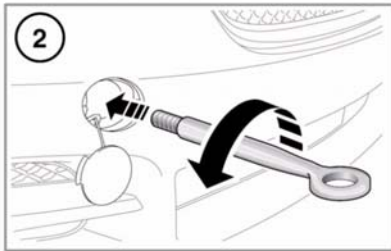
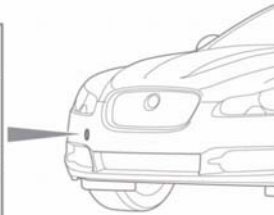
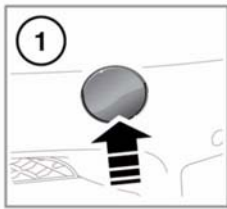

E134353



The towing eyes at the front and rear of the vehicle are designed for on-road recovery only.



Do not tow the vehicle on all four wheels.

ATTACHING THE FRONT TOWING EYE

The front towing eye is included in the tool kit, located in the under-floor area of the luggage compartment.

1. Pop out the cover in the front bumper.
2. Locate the towing eye through the bumper and screw the towing eye anticlockwise into its fixing, until secure.
3. Rear towing eye.

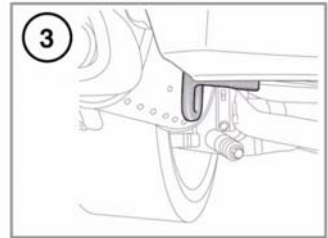
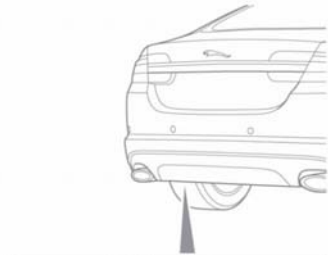

TRANSPORTING THE VEHICLE



Only use the lashing points indicated, or over-wheel lashings or wheel chocks. Use of any other lashing position may cause damage to the vehicle.



During vehicle recovery, to ensure the steering column remains unlocked, make sure the Smart Key remains in the vehicle, the rotary gear selector is in **N** (Neutral) and the ignition is on.

The recommended method for recovery/transportation of the vehicle, is on a transporter or trailer designed for that purpose.

Ensure that transportation is carried out by suitably qualified persons, and that the vehicle is secured correctly.

After a collision

BEFORE STARTING OR DRIVING



If the vehicle is involved in a collision it should be checked by a Dealer/ Authorised repairer, or suitably qualified personnel, before starting or driving.

PEDESTRIAN PROTECTION SYSTEM

The bumper includes sensors that detect a collision with a pedestrian and includes energy absorbing foam and plastics in its construction, to reduce leg injuries.

During a pedestrian collision, the sensors initiate a bonnet deployment system that releases the bonnet hinge system and raises the rear edge of the bonnet by approximately 130 mm (5.1 inches).

This increases the gap between the bonnet and the components within the engine compartment to create a cushion to mitigate injury caused to the pedestrian.

The bonnet deployment system is active only when the ignition is on and the vehicle is driven between the speeds of approximately 20 km/h (12 mph) and 45 km/h (28 mph).

AFTER DEPLOYMENT OF THE PEDESTRIAN PROTECTION SYSTEM



Do not attempt to open the bonnet if the pedestrian protection system has been deployed.

The vehicle must be stopped as soon as it is safe to do so.

The hazard warning lamps will be activated and can only be switched off by pressing the engine START/STOP button to turn the engine off and on again.

A warning message **CHECK PEDESTRIAN SYSTEM** will appear on the message centre and the vehicle should be transported to the nearest Dealer/Authorised Repairer. The vehicle must not be driven when the bonnet has been deployed.

***Note:** If the warning message **CHECK PEDESTRIAN SYSTEM** appears in the message centre when the bonnet has not been deployed, the vehicle should be taken to the nearest Dealer/Authorised Repairer immediately. It can be driven.*

If any significant damage occurs to the front bumper it should be inspected by a Dealer/Authorised Repairer as soon as possible.

EVENT DATA RECORDING

Event data recorders are capable of collecting and storing data during a crash or near-crash event. The recorded information may assist in the investigation of such an event. The modules may record information about both the vehicle and the occupants, potentially including such information as:

- How various systems in your vehicle were operating.
- Whether or not the driver and passenger seat belts were buckled.
- How far, if at all, the driver was pressing the accelerator and/or brake pedal.
- How fast the vehicle was travelling.
- Where the driver was positioning the steering wheel.

To access this information special equipment must be connected directly to the recording modules. Jaguar cars Limited do not access event data recorder information without obtaining consent, unless pursuant to court order or where required by law enforcement, other government authorities or third parties acting with lawful authority.

Other parties may seek to access the information independently of Jaguar Cars Limited.

Vehicle identification

LABEL LOCATIONS



Warning labels attached to your vehicle bearing this symbol mean: Do not touch or adjust components until you have read the relevant instructions in the handbook.



Labels showing this symbol indicate that the ignition system utilises very high voltages. Do not touch any ignition components while the starter switch is turned on.

Additional information labels may also be found at these locations.

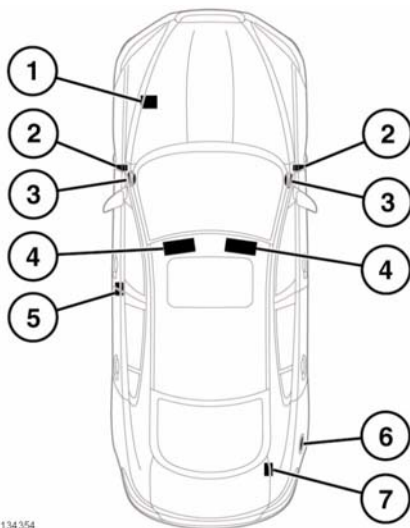

E134354

1. Left-hand front suspension tower - Air conditioning label

2. Vehicle Identification plate, including the Vehicle Identification Number (VIN) and recommended maximum vehicle weights.
- **Left-hand A pillar:** All markets except China.
 - **Right-hand A pillar:** China.

Note: The VIN number is also stamped on a plate, visible through the bottom left hand side of the windscreen.

3. End of fascia (passenger side) - Passenger airbag label
4. Sun visor - Airbag label
5. Base of left B pillar - Tyre pressure label, Airbag warning label.
6. Inner face of fuel filler flap - Fuel specification label
7. Top face of battery - Battery warning symbols

It is important that you are familiar with these subjects to ensure that your vehicle and its features are used safely. Using the index at the back of this handbook, refer to the relevant topic for more information.

ENGINE NUMBER

***Note:** To access the number, it may be necessary to remove the engine covers. For further assistance, contact your Dealer/ Authorised Repairer.*

I4 Diesel engines: Located on the left side of the cylinder block, near the sump.

V6 Diesel engines: Located on a metal label attached to the top of the left-hand camshaft cover.

V6 petrol engines: Located on the lower left-hand side of the cylinder block, near the bedplate.

V8 petrol engines: Located on the front of the right-hand cam cover.

TRANSMISSION NUMBER

The transmission number is located on a label attached to the transmission casing.

VEHICLE BUILD DATE PLATE (Australia only)

The vehicle built date is shown on the VIN plate.

DECLARATIONS OF CONFORMITY

SIEMENS VDO
A U T O M O T I V E

Siemens VDO Automotive AG, Postfach 18 18 41, D-93055 Regensburg

Name: Schneider Trautz
Department: SV C BC P2 RF TG
Phone: +49(0)941/796-6622
Fax: +49(0)941/796-139522
E-Mail: trautz.schneider@siemens.com
Internet: www.siemensvdo.de
Your Letter: Doc. SWK48956.doc
Our Ref.: 18.01.2006

Declaration of Conformity

We, the undersigned, declare that
the transmitter SWK48956 uses the same schematic, layout and pcb as
transmitter SWK4 8956.

They only differ in:

Capacitor C301, 680pF/2%, was changed to capacitor C311, 680pF/2%,
Resistor R302, 18kOhm was changed to resistor R322, 33kOhm,
Capacitor C103, 10nF was changed to capacitor C103, 22nF.

These modifications were necessary to adapt several car lines.

These modifications do not influence the RF characteristics of the transmitter.

Yours truly,

Siemens VDO Automotive AG
Regensburg, 18.01.2006

i.v. Martin Fischer
Dr. Martin Fischer
Vice President
Body and Chassis Electronics

Siemens VDO Automotive AG
Body & Chassis Electronics
Helmuth Matzki
Klaus Müller
Postfach 18 18 41
Siemens VDO Automotive AG
D-93055 Regensburg
P.O. Box 10 09 43
93055 Regensburg

Siemens VDO Automotive AG, Chairman of the Supervisory Board: Bernd E. Albrecht, Managing Director: Frank Immers, Chairman: Markus Kroll, Sign.
Siemens Regensburg, Johann Strauß-Platz 2, Regensburg (Germany) 93055, 10000
IPOST: 0941/796/Postfach-Regensburg/93055/SWK48956_SVK48956.doc Page 1 of 1

SIEMENS VDO
A U T O M O T I V E

Siemens VDO Automotive AG, P.O. Box 18 18 41, D-93055 Regensburg

Name: Regina Ouwewer
Department: SV C BC P2 RF TG
Tel: +49(0)941/796-3554
Fax: +49(0)941/796-133 554
E-Mail: Regina.Ouwewer@siemens.com
Internet: www.siemensvdo.de
Doc. SWK48956.doc
Date: 18/12/2003

Declaration of Conformity in accordance with Directive 1999/5/EC (R&TTE Directive)

Manufacturer: Siemens VDO Automotive AG
Body & Chassis Electronics

Address: Dep. SV C BC P2 RF TG
Siemensstrasse 12
D-93055 Regensburg
Germany

Product type designation: SWK4 8956

Intended use: Radio frequency transmitter used in vehicle locking/unlocking systems
The product mentioned above complies with the essential requirements and other relevant
provisions of Directive 1999/5/EC, when used for its intended purpose.

Health and safety pursuant to § 3.1 a:
Applied standard(s):
EN 60950; 2000

Electromagnetic compatibility pursuant to § 3.1 b: Applied standard(s):
EN 301 489-01, -3, V.1.4.1 (2002-08)
Efficient use of spectrum pursuant to § 3.2: Applied standard(s):
EN 300 220 -1, V.1.3.1 (2000-09)

The following marking applies to the above mentioned product:



Siemens VDO Automotive AG
Regensburg, 2003-12-16

i.v. Jean-Francois Tarabilla
Jean-Francois Tarabilla
Executive Vice President
Body & Chassis Electronics
Operations

Siemens VDO Automotive AG
Body & Chassis Electronics
Helmuth Matzki
Klaus Müller
Postfach 18 18 41
Siemens VDO Automotive AG
D-93055 Regensburg
P.O. Box 10 09 43
93055 Regensburg

Siemens VDO Automotive AG, Chairman of the Supervisory Board: Bernd E. Albrecht, Managing Director: Frank Immers, Chairman: Markus Kroll, Sign.
Siemens Regensburg, Johann Strauß-Platz 2, Regensburg (Germany) 93055, 10000
IPOST: 0941/796/Postfach-Regensburg/93055/SWK48956_SVK48956.doc Page 1 of 2

EC-Declaration of Conformity

Manufacturer: Valeo Raytheon Systems, Inc.
Address/Location: EU: Lahnstrasse 12, 74321 Bietigheim-Bissingen, Germany.
(USA: 150 Stephenson Highway, Troy, MI 48063 USA)

Declares that the product:

Type: MultiBeam Radar 24GHz
model: MBR Gen2
Intended use: Blind Spot Detection

complies with the essential requirements of Article 3 of the R&TTE 1999/5/EC Directive, if used for its intended use and that the following standards has been applied:

- 1 Health (Article 3.1 of the R&TTE Directive)
Applied Standard EN 50385 Issue 2002
- 2 Safety (Article 3.1 of the R&TTE Directive)
Applied Standard EN 60950-1 Issue 2005
- 3 Electromagnetic Compatibility (Article 3.1.b of the R&TTE-Directive)
Applied Standard ETSI EN 301 489-1 Issue V1.6.1
ETSI EN 301 489-3 Issue V1.4.1
- 4 Efficient Use of the radio frequency spectrum (3.2 of the R&TTE-Directive)
Applied Standard ETSI EN 300 440-1 Issue V1.3.1
ETSI EN 300 440-2 Issue V1.1.2

10/10/2007 Eric Amiot

(Place and date of the declaration of conformity)

(Name and signature)



A

- ABS (Anti-lock braking system)
 - warning lamp 52
- ACC (Adaptive cruise control) 96
 - ASL (Active speed limiter) 103
 - ASL (Automatic speed limiter)
 - setting 103
 - suspending 103
 - automatic switch-off 98
 - driving hints 99
 - fault 100
 - follow mode 97
 - gap change 98
 - low speed switch-off 98
 - malfunction 100
 - override 98
 - resume follow mode 99
 - resume set speed 99
 - warning lamp 53
- ACC (adaptive cruise control)
 - operating 96
- Active differential control 85
- Active head restraints
 - airbags 32
- Adaptive dynamics 84
- Adaptive front lighting system (AFS)
 - warning lamp 53
- AFS (Adaptive front lighting system) 37
- After a collision
 - pedestrian protection system 198
- Age degradation (tyres) 186
- Air conditioning
 - air quality sensor 65
 - auto 65
- Air quality sensor 65
- Airbags
 - active head restraints 32
 - deployment 33, 34
 - module covers 167
 - service information 35
 - SRS (Supplementary restraint system) 158
 - warning lamps 34, 53
- Alarm 10, 158
 - automatic relocking and arming 11
 - battery backed sounder 11
 - deactivating 11
 - passive arming 11
 - perimeter 11
 - sensor fault 11
 - tilt sensor 11
- Anchor points (ISOFIX) 30
- Anchor points (luggage) 68
- Antifreeze level check 170
- Anti-theft system 158
- Anti-trap mechanism
 - sunroof 43
- Anti-trap protection
 - windows 43
- Approach lamps 37
- Arduous driving conditions 159
- ASL (Automatic speed limiter) 103
 - gap change 98
 - resuming 103
 - setting 103
 - suspending 103
 - warning lamp 53, 103
- Audible warnings 55
- Audio
 - Settings 105
- Audio system 166
- Audio/video
 - CD
 - controls 120
 - controls 104
 - DAB
 - reception 112
 - loading CDs 119
 - loading DVDs 125
 - MP3 119
 - portable media
 - connections 113
 - controls 115
 - pairing 117, 118
 - play 117
 - television
 - controls 122

Index

- video media player
 - controls 124
- Auto high beam 38
- Auto mode (climate) 65
- Automatic gearbox 81
- Automatic locking 7
- Automatic reconnection (portable audio) 118
- Automatic Stop/Start 79
- Automatic switch off (ACC) 98
- Automatic switch off (cruise) 95
- Auxiliary devices
 - connecting multiple devices 117
- B**
- Battery
 - boost starting 183
 - care 182
 - changing
 - timed climate remote 184
 - charging 184
 - jump starting
 - connecting cables 183
 - disconnecting cables 183
 - monitoring system 183
 - warning symbols 182
- Battery backed sounder 11
- Beltminder 26
 - warning lamp 26, 52
- Belts 167
 - safety 23
 - seatbelt warning lamp 26, 52
- Bluetooth 129
 - audio
 - automatic reconnection 118
 - pairing 117, 118
 - media
 - pairing 117
 - telephone
 - compatibility 130
 - icons 131
 - overview 128
 - pairing 130
 - phonebook 132
 - safety 129
- Bonnet
 - closing 160
 - opening 160
- Boost starting 183
- Brakes
 - ABS warning lamp 52
 - advanced emergency assist 101
 - EBA (Emergency brake assist) 87
 - EBD (Electronic brake force distribution) 87
 - fluid
 - check 171
 - specification 172
 - top up 172
 - handbrake 88
 - pedal travel 180
 - warning lamp 51
 - warning lamps 87
- BSM (Blind spot monitor) 46
 - detection beam issues 99
 - sensor blockage 47
 - system fault 47
- Bulbs
 - license plate 163
 - number plate 163
- C**
- Call volume 132
- Cameras
 - rear view 93
- Capacities 179
- Carpets and mats 167
- Car-wash 165
- CD player
 - controls 120
 - loading discs 119
- Chairs
 - child seats
 - tether straps 31
 - memory
 - recalling a position 15

- rear
 - safety 17
- seatbelts 167
 - seatbelt safety 23
 - warning lamp 26, 52
 - sitting correctly 15
- Changing a fuse 188
- Changing a tyre 90
- Changing a wheel 90
- Changing the battery (timed climate) 184
- Charging the vehicle battery 184
- Chassis number 200
- Child restraints 27
 - check list 28
 - positioning 29
- Child seats 27
 - check list 28
 - ISOFIX anchor points 30
 - positioning 29
 - tether straps 31
- Cleaning
 - alloy wheels 164
 - carpets and mats 167
 - exterior 164
 - paintwork 165
 - glass 165
 - interior 165, 166
 - leather 166
 - parking sensors 93
 - polishing 165
 - rear screen 165
 - removing grease 165
 - removing stains 166
 - removing tar 165
 - sunroof 165
 - underbonnet 165
 - using a car-wash 165
- Climate control
 - auto 65
 - overview 65
 - recirculation 64
 - temperature 65
- Climate seats 66
- Clock 166
- Closing
 - alarm sensor faults 11
 - single locking 9
- Closing the bonnet 160
- Closing the luggage compartment 67
- Column lock 75
- Condensation (headlamps) 38
- Conformity declarations 146, 202
- Consumption
 - fuel
 - urban cycle 157
- Consumption (fuel) 157
- Controls
 - headlamps 36
 - steering wheel
 - set cruise speed 94
- Coolant
 - checking the level 170
 - specification 171
 - top up 171
- Cruise control
 - ACC (Adaptive cruise control) 96
 - low speed switch-off 98
 - malfunction 100
 - operating 96
 - override 98
 - resume follow mode 99
 - resume set speed 99
 - automatic switch off 95
 - change speed 94
 - follow mode 97
 - operating 94
 - resume 94
 - setting vehicle speed 94
- D**
- DAB
 - ensembles 112
 - reception 112
- DAB radio
 - controls 111

Index

- Daily checks 158
- Data recording 199
- Daylight running lamps 37
- Dealer locations (Jaguar) 141
- Declarations of conformity 202
 - navigation system 146
- Derv
 - sulphur content 153
- Deselecting valet mode 62
- Destination entry 138
 - postcode 140
 - search area 138
 - town 141
- Detection beam issues 99
- Dialling a number 132
- Diesel
 - engine 153, 154
 - starting 74
 - switching off 75
 - filler flap 154, 155
 - fuel consumption 157
 - misfuel device 155
 - specification 156
 - sulphur content 153
 - water in fuel 153
- Diesel particulate filter (DPF) 159
- Differential control 85
- Dimensions 178
- Direction indicators 36
 - warning lamp 54
- Disability modifications 158
- Door mirrors
 - BSM (Blind spot monitor)
 - sensor blockage 47
 - system fault 47
- Door transceiver
 - entry gate 50
 - garage door opener 48
 - programming 48
 - programming a single button 49
 - rolling code device programming 49
- Double locking 9
- DPF (Diesel particulate filter) 159
- Drive away locking 7
- Drive control
 - operation 86
- Driver controls 226
- Driver information module
 - information messages 56
 - trip computer 56
 - warning lamps 51
 - warning messages 56
- Driving
 - ACC (Adaptive cruise control) 96, 99
 - override 98
 - adaptive cruise control
 - automatic switch off 98
 - arduous conditions 159
 - ASL (Automatic speed limiter) 103
 - setting 103
 - before starting 198
 - BSM (Blind spot monitor)
 - sensor blockage 47
 - controls 226
 - cruise control
 - automatic switch off 95
 - change speed 94
 - set speed 94
 - daily checks 158
 - DSC warning lamp
 - active 53
 - off 53
 - dynamic mode 83
 - EBA (Emergency brake assist) 87
 - EBD (Electronic brake force distribution) 87
 - forward alert 100
 - mirror dip when reversing 45
 - sitting correctly 15
 - wipers
 - rain sensor 40
- DSC (Dynamic stability control)
 - switching between DSC and tracDSC 84
 - switching off 84
 - switching on 84

- warning lamp
 - active 53
 - off 53
- warning lamps 84
- DVDs
 - loading 125
- Dynamic mode 83
- E**
- EBA (Emergency brake assist) 87
- EBD (Electronic brake force distribution) 87
- ECO Stop/Start 79
- Electric seats
 - front 12
- Electronic brake force distribution (EBD) 87
- Electronic data 199
- Electronic parking brake (EPB) 88
- Emergency brake assist (EBA) 101
- Engine
 - compartment
 - cleaning 165
 - fuse box 189
 - opening 160
 - overview 161
 - coolant level checking 170
 - diesel 153, 154
 - starting the engine 74
 - DPF (Diesel particulate filter) 159
 - engine compartment 161
 - engine malfunction warning lamp 52
 - failure to start 76
 - malfunction warning lamp 52
 - Number 201
 - oil consumption 170
 - oil level check 168
 - oil level consumption 170
 - oil specification 169
 - petrol
 - starting the engine 74
 - specifications 175
 - starting
 - petrol 77
 - switching off 75
- Ensembles (DAB radio) 112
- Entering a destination 138
 - by town 141
- Entering the vehicle
 - entry and exit mode 22
 - keyless entry 6
- Entertainment
 - CD
 - controls 120
 - DAB radio
 - controls 111
 - navigation
 - all softkey 142
 - coordinates 140
 - list 142
 - menu 135
 - motorway 141
 - POI categories 141
 - POI (Points of interest) 139, 141
 - postcode 140
 - previous 140
 - restore defaults 140
 - TMC 142
 - TMC display 142
 - TMC icons 143
 - portable media
 - automatic reconnection 118
 - changing device 118
 - connecting devices 113
 - connecting multiple devices 117
 - connections 113
 - controls 115
 - lost connection 118
 - pairing 117, 118
 - playing 117
 - radio
 - controls 109
 - RDS (Radio data system) 110
 - RSE (Rear screen entertainment)
 - screen settings 60
 - telephone
 - last 10 133

Index

- pairing 130
- phonebook 132
- settings 133
- television
 - analogue/digital option 123
 - controls 122
- touch screen 166
 - display icons 59
 - home menu 58
 - operating 59
 - setup 59
 - system settings 60
 - touch screen care 59
- video media player
 - controls 124
- Entry and exit mode 22
- EPB (Electric parking brake) 88
- Ethanol 152
- EU conformity (navigation system) 146
- Event data recording 199
- Exiting the vehicle
 - door locks and release levers 9
 - global closing 10
 - keyless locking 10
- Exterior cleaning 164
- Exterior mirrors 44
- External temperature display 65
- Extinguisher 164

- F**
- Faulty alarm sensors 11
- Fire extinguisher 164
- First aid kit 164
- Flat spots 186
- Fluids
 - brake
 - check 171
 - specification 172
 - top up 172
 - capacities 179
 - coolant
 - specification 171
 - top up 171
 - engine oil
 - check 168
 - specification 169
 - fuel tank capacity 156
 - power steering
 - check 173
 - specification 173
 - specifications 175
 - washer
 - specification 174
 - top up 174
- Fog lamps
 - warning lamp 53
- Follow mode
 - entering 97
 - gap change 98
 - override 98
 - resume 99
 - suspending 103
- Forward alert 100
- Front parking aid
 - operation 92
 - system fault 93
- Fuel and refuelling
 - consumption 157
 - extra-urban cycle 157
 - urban cycle 157
 - diesel 153
 - sulphur content 153
 - ethanol 152
 - Filler flap 155
 - filler flap 154
 - fuel consumption
 - urban cycle 157
 - fuel specification 156
 - fuel system 160
 - methanol 152
 - misfuel device 155
 - MTBE (Methyl tertiary butyl ether) 153
 - octane rating 152
 - running out 153
 - safety precautions 152

- tank capacity 156
- water in fuel 153
- Fuses
 - changing 188
 - engine compartment fuse box 189
 - locations 188
 - luggage compartment fuse box 192
 - Passenger compartment fuse box 191
- G**
- Garage door opener 48
 - entry gate 50
 - erase all programming 49
 - programming 48
 - a single button 49
 - rolling code device 49
- Gear selector 82
 - malfunction 82
- Gearbox
 - automatic 81
 - identification number 201
 - limp home mode 82
 - operation 86
 - selector 82
 - selector malfunction 82
 - temporary manual selection 82
 - winter mode 83
- Glass cleaning 165
- Global closing 10
- Global opening 7
- H**
- Handbrake 88
- Handling
 - adaptive dynamics 84
 - DSC warning lamp
 - active 53
 - off 53
 - dynamic mode 83
 - EBD (Electronic brake force distribution) 87
- Head restraints 20
 - active 32
 - manual 21
 - removing 21
- Headlamps
 - adaptive 37
 - AFS (Adaptive front lighting system) 37
 - approach lamps 37
 - auto high beam 38
 - condensation 38
 - controls 36
 - daylight running lamps 37
 - high beam warning lamp 54
 - warning lamp (AFS) 53
 - washers 41
 - wiper detection 37
- Heated screens 64
- Heated seats 65
- Heated steering wheel 22
- Heating and ventilation
 - auto 65
 - recirculation 64
- High beam
 - automatic 38
 - warning lamp 54
- Homelink 48
 - programming a single button 49
 - rolling code device programming 49
- I**
- Identifying the vehicle
 - transmission number 201
- Ignition
 - rolling re-start 77
 - switching off while moving 77
 - switching on 74
- Indicators 36
 - warning lamp 54
- Information messages 56
- Infotainment
 - CD
 - controls 120
 - DAB radio
 - controls 111

Index

- navigation
 - all softkey 142
 - coordinates 140
 - list 142
 - menu 135
 - motorway 141
 - POI categories 141
 - POI (Points of interest) 139, 141
 - postcode 140
 - previous 140
 - restore defaults 140
 - TMC 142
 - TMC display 142
 - TMC icons 143
 - portable media
 - automatic reconnection 118
 - changing device 118
 - connecting devices 113
 - connecting multiple devices 117
 - connections 113
 - controls 115
 - lost connection 118
 - pairing 117, 118
 - playing 117
 - radio
 - controls 109
 - RDS (Radio data system) 110
 - RSE (Rear seat entertainment)
 - screen settings 60
 - telephone
 - last 10 133
 - pairing 130
 - phonebook 132
 - settings 133
 - television
 - analogue/digital option 123
 - controls 122
 - touch screen 166
 - display icons 59
 - home menu 58
 - operating 59
 - setup 59
 - system settings 60
 - touch screen care 59
 - video media player
 - controls 124
 - Inhibited media playback 125
 - Instrument pack 166
 - Instrument panel
 - information messages 56
 - lamp test 51
 - trip computer 56
 - warning lamps 51
 - side lights 54
 - warning messages 56
 - Intelligent Stop/Start 79
 - Interior cleaning 165, 166
 - carpets and mats 167
 - Interval indicator 57
 - ISOFIX anchor points 30
- ## J
- Jaguar dealer locations 141
 - Jaguar voice 126
 - training 127
 - tutorial 126
 - voicetags 127
 - Jaguardrive control
 - operation 86
 - Jump starting
 - connecting cables 183
 - disconnecting cables 183
- ## K
- Keyless entry 6
 - Keyless locking 10
 - Keys
 - single locking 9
- ## L
- Label locations 200
 - Lamp test 51
 - Lamps
 - condensation 38
 - controls 36

- warning lamps 51
 - side lights 54
 - TPMS (Tyre pressure monitoring system) 53
 - wiper detection 37
- Leather cleaning 166
- License plate bulb 163
- Lights
 - condensation 38
 - controls 36
- Limp home mode 82
- List soft key (navigation) 142
- Load securing 68
- Loading DVDs 125
- Locking
 - alarm sensor faults 11
 - automatic relocking 11
 - confirmation 9
 - door locks and release levers 9
 - double locking 9
 - drive away 7
 - global closing 10
 - keyless 10
 - mislock 10
- Locking and unlocking
 - alarm
 - perimeter 11
 - sensor faults 11
 - passive arming 11
 - single locking 9
 - unlocking 4
- Locking column 75
- Lubricants
 - specifications 175
- Luggage
 - anchor points 68
- Luggage compartment
 - closing 67
 - fuse box 192
 - opening 67
- M**
 - Main beam (auto) 38
 - Maintenance
 - blocked washer jets 162
 - boost starting
 - connecting cables 183
 - disconnecting cables 183
 - brake fluid check 171
 - capacities 179
 - changing a fuse 188
 - checking the tyre pressures 185
 - checking the tyre pressures after a repair 150
 - cleaning
 - polishing 165
 - removing grease and tar 165
 - removing stains 166
 - cleaning alloy wheels 164
 - cleaning glass 165
 - cleaning parking sensors 93
 - cleaning rear screen 165
 - closing the bonnet 160
 - coolant level checking 170
 - daily checks 158
 - DPF 159
 - engine compartment 161
 - exterior cleaning 164
 - fuse box (luggage compartment) 192
 - interior cleaning 165, 166
 - jump starting 183
 - label locations 200
 - leather cleaning 166
 - lubricants and fluid specifications 175
 - number plate bulb 163
 - paintwork repair 164
 - smart key battery changing 8
 - sunroof wind deflector 165
 - weekly checks 158
 - Manual head restraints 21
 - Map (navigation system) 140
 - Map split screen (navigation system) 137
 - Media 125
 - inhibited 125

Index

portable	
lost connection	118
play	117
portable media	
connections	113
Memory points (navigation system)	140
Memory seats	
recalling a position	15
Message centre	
trip computer	56
change display	56
range	56
Methanol	152
Minor paintwork damage repair	164
Mirrors	
BSM (Blind spot monitor)	46
system fault	47
dip when reversing	45
Mirrors and windows	
BSM (Blind spot monitor)	
detection beam issues	99
sensor blockage	47
exterior mirrors	44
sunroof	
anti-trap mechanism	43
reset	164
Misfuel device	155
Modifications for disabilities	158
Monitoring system (battery)	183
Moon roof	
anti-trap mechanism	43
reset	164
MP3	119
mpg	157
MTBE (Methyl tertiary butyl ether)	153
N	
Navigation	
all softkey	142
cancel guidance	139
destination entry	138
coordinates	140

emergency	140
motorway	141
postcode	140
previous	140
search area	138
start guidance	139
entering a destination town	141
list	142
map	140
map split screen	137
memory points	140
menu	135
operating	134
overview	134
POI (Points of interest)	141
categories/sub-categories	141
quick POI selection	139
POI search	142
restore defaults	140
screen modes	138
TMC	142
display	142
icons	143
using TMC	144
traffic event icons	143
voice commands (POI)	127
voice guidance	139
Number plate bulb	163

O

Occupant safety	
child seats	
tether straps	31
seatbelts	167
seatbelt safety	23
warning lamp	26, 52
Oil	
engine	
consumption	170
level check	168
engine oil specification	170
engine oil specifications	169

- used engine oil 160
- One-touch operation (windows) 43
- Opening
 - alarm sensor faults 11
 - bonnet 160
 - luggage compartment 67
- Overriding speed and follow mode (cruise) 98

- P**
- Paddle shift
 - temporary manual selection 82
- Paintwork
 - cleaning 165
 - repair 164
- Parking aid 92
 - rear view camera 93
 - sensor cleaning 93
 - system fault 93
- Parking brake 88
- Passenger compartment fuse box 191
- Passive arming 11
- Pedestrian protection system 198
 - after deployment 198
- Perimeter alarm 11
- Petrol
 - consumption 157
 - engine
 - starting 74
 - switching off 75
 - octane rating 152
 - specification 156
- Petrol engine
 - starting 77
- Petrol filler flap 154, 155
- Phone
 - bluetooth 129
 - call volume 132
 - changing connected phone 131
 - compatibility 130
 - controls
 - steering wheel 132
 - dialling 132
 - icons 131
 - last 10 133
 - overview 128
 - pairing using mobile phone 130
 - pairing using touch screen 130
 - phonebook 132
 - safety 129
 - settings 133
 - POI (Points of interest) 141
 - search 142
 - Portable media
 - automatic reconnection 118
 - changing device 118
 - connecting devices 113
 - connecting multiple devices 117
 - connections 113
 - controls 115
 - lost connection 118
 - pairing 117, 118
 - playing 117
 - Positioning child restraints 29
 - Power steering
 - fluid
 - check 173
 - specification 173
 - Pressure
 - checking 185
 - Pressures
 - checking
 - after a repair 150
 - tyres 185
 - winter tyres 187
 - Previous destination (navigation system) . 140
 - Programming
 - garage door opener 48
 - erase all 49
 - Puncture repair kit 147
 - instructions for use 149
 - repair procedure 149
 - safety 147
 - Punctured tyres 186

Index

R

Radio	
controls	109
DAB ensembles	112
DAB reception	112
RDS (Radio data system)	110
Rain sensor	40
RDS (Radio data system)	110
RDS-TMC	142, 144
display	142
icons	143
Rear media	
screen settings	60
Rear screen cleaning	165
Recalling seat memory position	15
Reception (DAB)	112
Recirculation	64
Reconnection (portable audio)	118
Recovery	
towing eyes	197
transporting	197
Refuelling	
diesel	153
sulphur content	153
octane rating	152
running out of fuel	153
safety precautions	152
Remote control	
battery changing	8
care	7
system transmitters	181
Removing the head restraints	21
Repairing paintwork damage	164
Replacement sensor (TPMS)	91
Replacement tyres	186
Resetting the windows	164
Restarting the engine whilst moving	77
Restore default settings (navigation system)	140
Restraints (child)	27, 28
positioning	29
Resume speed and follow mode (ACC)	99
Resuming set speed (ASL)	103

Resuming set speed (cruise)	94
Reverse parking aid	
operation	92
rear view camera	93
system fault	93
Rolling re-start	77
RSE (Rear seat entertainment)	
screen settings	60
Running out of fuel	153

S

Safety	
fuel and refuelling	152
in the garage	159
seatbelts	23, 167
warning lamp	26, 52
sitting correctly	15
tyre care	185
used engine oil	160
using the telephone	129
warning triangle	164
Satellite navigation	
all softkey	142
cancel guidance	139
destination entry	138
coordinates	140
postcode	140
previous	140
search area	138
start guidance	139
emergency	140
entering a destination town	141
list	142
map	140
map split screen	137
memory points	140
menu	135
motorway	141
operating	134
overview	134
POI (Points of interest)	141
categories	141

- quick POI selection 139
- POI search 142
- restore defaults 140
- screen modes 138
- TMC 142
 - display 142
 - icons 143
- traffic event icons 143
- using TMC 144
- voice commands (POI) 127
- voice guidance 139
- Screen modes (navigation system) 138
- Screens (heated) 64
- Search area (navigation system) 138
- Seatbelts 167
 - beltminder 26
 - beltminder warning lamp 52
 - checks 23
 - safety 23
 - warning lamp 26, 52
- Seats
 - child seats
 - tether straps 31
 - climate 66
 - electric
 - front 12
 - head restraints 20
 - heated 65
 - manual head restraints 21
 - memory
 - recalling a position 15
 - rear
 - safety 17
 - removing the head restraints 21
 - seatbelts 167
 - safety 23
 - warning lamp 26, 52
 - sitting correctly 15
- Securing luggage 68
- Security 10
 - alarm 158
 - passive arming 11
 - perimeter 11
 - tilt sensor 11
 - automatic relocking and arming 11
 - battery backed sounder 11
 - deactivating the alarm 11
 - lock confirmation 9
 - sensor faults 11
 - steering column lock 75
- Selecting valet mode 61
- Selector fails to elevate 82
- Sensors
 - blockage (BSM) 47
 - replacements (TPMS) 91
 - security sensor faults 11
- Service information
 - airbags 35
- Service interval indicator 57
- Servicing
 - interval indicator 57
- Setting a destination (navigation) 138
- Setting cruise speed 94
- Settings
 - rear media 60
 - telephone 133
 - vehicle 61
- Side lights
 - warning lamp 54
- Silencing the alarm 11
- Sitting correctly 15
- Smart key
 - battery changing 8
 - care 7
 - single locking 9
 - transmitters 181
- Snow chains 187
- Specifications
 - brake pedal travel 180
 - dimensions 178
 - engine 175
 - Engine number 201
 - engine oil 169
 - ethanol 152
 - fluids 175
 - washer 174

Index

- fuel 156
- Fuel tank capacity 156
- label locations 200
- lubricants 175
- methanol 152
- weight 176
- wheel alignment 180
- Speed limiter
 - setting 103
- Speed-dependent wipers 40
- Split screen map 137
- SRS
 - Airbags 158
- SRS (Supplementary restraint system)
 - airbag covers 167
 - airbag deployment 34
 - airbag warning lamp 34, 53
 - child seat check list 28
 - child seat positioning 29
 - child seats 27
 - ISOFIX Anchor points 30
 - seatbelts (beltminder) 26
 - seatbelts (beltminder) warning lamp ... 52
- Stability control
 - switching between DSC and tracDSC .. 84
 - switching off 84
 - switching on 84
 - tracDSC 83
 - switching between tracDSC and DSC. 84
 - warning lamps 84
- Starting
 - preparation 198
- Starting navigation guidance 139
- Starting the engine
 - diesel engine 74
 - petrol engine 74, 77
- Steering column lock 75
- Steering wheel
 - adjusting 22
 - column lock 75
 - controls
 - connect phone call 132
 - decrease volume 132
 - disconnect phone call 132
 - increase volume 132
 - scroll/search down 132
 - set cruise speed 94
 - voice control talk 132
 - heated 22
 - Steering wheel controls 132
 - Stop/Start 79
 - Storage compartments 72
 - cup holders 72
 - front cubby box 72
 - glove box 72
 - rear armrest 72
 - Sunroof
 - anti-trap mechanism 43
 - reset 164
 - Suspending ASL (Automatic speed limiter) 103
 - Switching off the engine 75
 - Switching off the ignition while moving ... 77
 - Switching on the engine
 - diesel engine 74
 - petrol engine 74
 - Switching on the ignition 74

T

 - Technical specifications
 - weights 176
 - wheel alignment 180
 - Telephone
 - bluetooth 129
 - call volume 132
 - changing the connected telephone ... 131
 - compatibility 130
 - controls
 - steering wheel 132
 - dialling 132
 - icons 131
 - last 10 133
 - overview 128
 - pairing 130
 - phonebook 132

- safety 129
- settings 133
- Television
 - analogue/digital option 123
 - controls 122
- Temperature (external) 65
- Tilt sensor 11
- Timed jet function 41
- TMC (Traffic message channel) 144
 - display 142
 - overview 142
- TMC (Traffice message channel)
 - icons 143
- Touch screen 166
 - CD
 - controls 120
 - display icons 59
 - home menu 58
 - navigation
 - all softkey 142
 - coordinates 140
 - list 142
 - menu 135
 - motorway 141
 - POI categories 141
 - POI (Points of interest) 139, 141
 - postcode 140
 - screen modes 138
 - search area 138
 - TMC 142
 - TMC display 142
 - TMC icons 143
 - operating 59
 - portable media
 - automatic reconnection 118
 - changing device 118
 - connecting devices 113
 - connecting multiple devices 117
 - connections 113
 - controls 115
 - lost connection 118
 - pairing 117, 118
 - playing 117
 - RSE (Rear seat entertainment)
 - screen settings 60
 - setup 59
 - system settings 60
 - telephone
 - last 10 133
 - pairing 130
 - phonebook 132
 - television
 - analogue/digital option 123
 - controls 122
 - touch screen care 59
 - valet mode 61
 - vehicle settings 61
 - video media player
 - controls 124
- Tow eye (front) 197
- Towing eyes 197
- TPMS (Tyre pressure monitoring system) . 89
 - overview 89
 - replacement sensor 91
 - tyre care 185
 - unavailable 90
 - valves 185
 - warning lamp 53
- tracDSC 83
 - switching between DSC and tracDSC . . . 84
 - warning lamps 84
- Traction control
 - switching between DSC and tracDSC . . . 84
 - switching off 84
 - switching on 84
 - tracDSC 83
 - switching between tracDSC and DSC . 84
 - warning lamps 84
- Traffic event icons 143
- Transmission
 - gear selector 82
 - identification number 201
 - limp home mode 82
 - operation 86
 - selector fails to elevate 82
 - temporary manual selection 82

Index

winter mode	83
Transmission (automatic)	81
Transmitters	
smart key	181
Transporting the vehicle	197
Trim	
airbag covers (cleaning)	167
Trip computer	56
change display	56
range	56
Turning on the engine	
diesel engine	74
petrol engine	74
TV	
analogue/digital option	123
controls	122
Tyre pressure checking	185
Tyre pressure checking after repair	150
Tyre pressure monitoring system (TPMS)	
replacement sensor	91
Tyre repair kit	
repair procedure	149
Tyres	
age degradation	186
changing	90
flat spots	186
pressures	185
winter tyres	187
punctured	186
repair kit	147, 149
repair procedure	149
safety	147
replacements	186
snow chains	187
temporary use spare	90
TPMS (Tyre pressure monitoring system)	89
overview	89
unavailable	90
warning lamp	53
tyre care	185
valves	185
winter	186

U

Underbonnet cleaning	165
Unlocking	4, 9
alarm sensor faults	11
entry and exit mode	22
global opening	7
keyless entry	6
passive arming	11
Urban cycle	157
Used engine oil	160
Using cruise control	94

V

Valet mode	61
deselecting	62
Vehicle alarm	158
Vehicle battery care	182
Vehicle cleaning	
alloy wheels	164
carpets and mats	167
exterior	164
interior	165, 166
parking sensors	93
rear screen	165
sunroof	165
Vehicle data recording	199
Vehicle handling	84
Vehicle identification	
transmission number	201
Vehicle recovery	
attaching the front tow eye	197
towing eyes	197
transporting the vehicle	197
Vehicle settings	61
valet mode	61
Video	
loading DVDs	125
Video media player	
controls	124
inhibited playback	125
VIN number	200
Voice control	126

- navigation POI 127
- training 127
- tutorial 126
- voicetags 127
- Voice guidance 139
- Volume
 - telephone 132

- W**
- Warning lamps 51
 - ABS 52
 - ACC 53
 - adaptive cruise control 53
 - adaptive front lighting system 53
 - AFS 53
 - airbags 34, 53
 - ASL (Automatic speed limiter) 53, 103
 - audible warnings and indicators 55
 - beltminder 52
 - brake 51
 - brakes 87
 - DSC 53
 - engine malfunction 52
 - fog lamps 53
 - headlamp high beam 54
 - indicators 54
 - lamp test 51
 - seatbelt 26, 52
 - side lights 54
 - TPMS (Tyre pressure monitoring system) 53
- warning lamps
 - stability control 84
- Warning messages 56
- Warning symbols (battery) 182
- Warning triangle 164
- Warranty 146
- Washer jets
 - blockages 162
- Washers
 - operating 40
 - timed jet function 41
- windscreen 41
- Washers (headlamps) 41
- Washing
 - exterior
 - paintwork 165
 - removing tar 165
 - interior
 - removing stains 166
 - polishing 165
 - removing grease 165
 - under the bonnet 165
- Water in fuel 153
- Weekly checks 158
- Weights 176
- Wheels and tyres
 - accessory 180
 - age degradation 186
 - changing a tyre 90
 - checking the pressures 185
 - checking the pressures after a repair 150
 - flat spots 186
 - pressures 185
 - puncture repair 147
 - safety 147
 - punctured 186
 - repair kit 147, 149
 - repair procedure 149
 - safety 147
 - replacements 186
 - snow chains 187
 - temporary use spare 90
 - TPMS (Tyre pressure monitoring system) 89
 - overview 89
 - unavailable 90
 - warning lamp 53
 - tyre care 185
 - tyre changing 90
 - tyre label 200
 - valves 185
 - wheel alignment 180
 - wheel changing 90
 - winter tyres 186, 187

Index

Windows	42
anti-trap protection	43
one-touch operation	43
reset	164
sunroof	
anti-trap mechanism	43
reset	164
Windscreen wipers	
speed-dependent mode	40
Windscreens (heated)	64
Wing mirrors	
BSM (Blind spot monitor)	
system fault	47
Winter mode	83
Winter tyres	187
pressures	187
Wipers	
drip wipe	41
operating	40
Wipers and washers	
fluid	
specification	174
top up	174
operating	40
rain sensor	40
timed jet function	41
windscreen washers	41
wipers	
speed-dependent mode	40
X	
Xenon headlamps	
wiper detection	37



Controls overview

DRIVER CONTROLS

1. Parking aid (92).
2. Front map reading lamps (39).
3. Front courtesy lamps (39).
4. Sunroof (42).
5. Rear screen sun blind (42).
6. Indicator/headlamp control (36).
7. Gearshift down (81).
8. Audio controls (104).
9. Instrument panel.
10. Cruise control or ACC controls (94/ 96).
11. Gearshift up (81).
12. Wipers/washers (40).
13. Touch screen (58).
14. Central locking/unlocking.
15. Touch screen on/off or Eco stop/start off (58/78).
16. Hazard warning lamps on/off.
17. Climate control or navigation menu (63/134).
18. Phone menu (Bluetooth® only) (128).
19. Home menu (58).
20. Glove box release.
21. Climate controls (63).
22. Heated screen switches (64).
23. Stability control (DSC) (84).
24. Speed limiter (ASL) (103).
25. Parking brake (88).
26. Dynamic mode (83).
27. Winter mode (83).
28. Gear selector (82).
29. Engine START/STOP button (74/74).
30. Audio controls (104).
31. Horn/airbag (32).
32. Steering column adjuster (22).
33. Voice/Phone make call button (132).
34. Bonnet release (160).
35. Starter control unit (76).
36. Fog lamps on/off.
37. Forward alert switch (100).
38. Boot release (67).
39. Instrument illumination - rotate to adjust.
40. Driving position memory (15).
41. Rear window isolator (42).
42. Window controls (42).
43. Mirror controls (44).

